

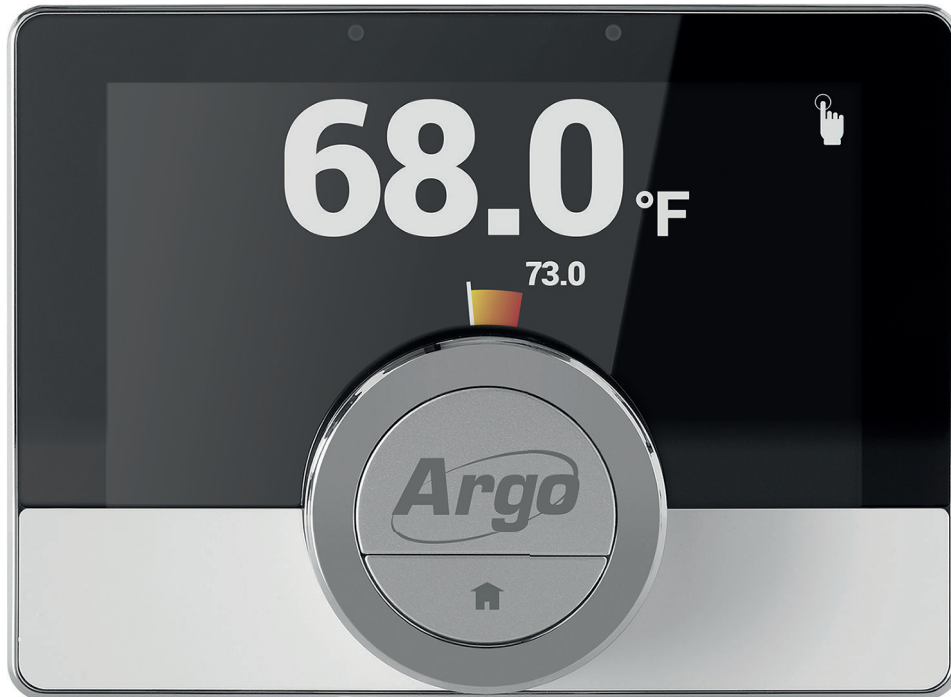

United States  
en



User manual  
Digital clock thermostat

Wi-Fi Thermostat



Manufactured by:  
ECR International Inc.  
2201 Dwyer Avenue, Utica, NY 13501  
Tel. 800 253 7900  
[www.ecrinternational.com](http://www.ecrinternational.com)

ECR p/n: 615000296

# Contents

- 1 Manual menu ..... 4**
- 2 Introduction ..... 5**
  - 2.1 Symbols used in the manual ..... 5
  - 2.2 Introducing the Wi-Fi Thermostat ..... 5
  - 2.3 The Wi-Fi Thermostat and its app ..... 6
  - 2.4 What's new for the Wi-Fi Thermostat ..... 6
  - 2.5 How to use the Wi-Fi Thermostat ..... 6
    - 2.5.1 Using the rotary dial and buttons ..... 6
    - 2.5.2 Entering the main menu and menu items ..... 6
    - 2.5.3 Entering the Quick Access menu and menu items ..... 7
    - 2.5.4 Returning to the previous step or home screen ..... 7
    - 2.5.5 Scrolling through menu items and changing settings ..... 7
    - 2.5.6 Screen shows no information ..... 8
  - 2.6 Description of the display ..... 8
    - 2.6.1 Description of the icons in the display ..... 8
    - 2.6.2 Customising the main screen display ..... 10
  - 2.7 Messages on the display ..... 10
  - 2.8 Presence detection ..... 11
  - 2.9 Zones control ..... 11
- 3 General use ..... 12**
  - 3.1 Changing the mode quickly ..... 12
  - 3.2 Changing the room temperature ..... 12
    - 3.2.1 Changing the temperature in manual mode ..... 12
    - 3.2.2 Changing the temperature for a short period in scheduling mode ..... 13
  - 3.3 Creating a temperature schedule to control the room temperature ..... 13
    - 3.3.1 Changing the weekdays of a temperature schedule ..... 13
    - 3.3.2 Copying a weekday of a temperature schedule ..... 15
    - 3.3.3 Selecting another temperature schedule ..... 15
  - 3.4 Setting a holiday schedule ..... 16
    - 3.4.1 Creating a holiday schedule ..... 16
    - 3.4.2 Changing a holiday schedule ..... 17
    - 3.4.3 Deleting a holiday schedule ..... 17
  - 3.5 Activating fireplace mode ..... 18
  - 3.6 Activating frost protection mode ..... 18
  - 3.7 Switching the central heating on/off ..... 18
- 4 Customisation ..... 20**
  - 4.1 Hot water settings ..... 20
    - 4.1.1 Changing the hot water temperature ..... 20
    - 4.1.2 Setting the hot water comfort mode ..... 20
    - 4.1.3 Setting the hot water reduced (energy-saving) mode ..... 20
    - 4.1.4 Changing the hot water schedule ..... 20
  - 4.2 Wi-Fi Thermostat settings ..... 21
    - 4.2.1 Setting the date and time ..... 21
    - 4.2.2 Setting country and language ..... 21
    - 4.2.3 Main screen setting ..... 22
    - 4.2.4 Show help messages ..... 22
    - 4.2.5 Presence sensor ..... 22
    - 4.2.6 Display current or target temperature ..... 22
    - 4.2.7 Child lock ..... 23
    - 4.2.8 Changing the name of an activity ..... 23
    - 4.2.9 Changing the name of a zone ..... 24
    - 4.2.10 Changing the display settings ..... 24
    - 4.2.11 Enabling time synchronization by internet ..... 25
    - 4.2.12 Enabling daylight saving ..... 25
    - 4.2.13 Changing unit system ..... 25
  - 4.3 Wi-Fi Thermostat connections ..... 25
    - 4.3.1 Establishing the wi-fi connection ..... 26
    - 4.3.2 Downloading the app ..... 26
    - 4.3.3 Connecting the app with the Wi-Fi Thermostat ..... 27
    - 4.3.4 Connecting your home automation application with the Wi-Fi Thermostat ..... 27
    - 4.3.5 Registering installer access ..... 27

4.4	Advanced settings	28
4.4.1	Resetting to default settings	28
4.4.2	Check for software update	28
4.4.3	Temperature calibration	28
4.4.4	Activating Preheat	29
4.5	Installer settings	29
4.5.1	Changing the heating curve	29
4.5.2	Setting the control strategy	30
4.5.3	Setting the heating rate	30
4.5.4	Setting the minimum central heating power	31
4.5.5	Setting the maximum central heating power	31
4.5.6	Setting maximum domestic hot water power	32
4.5.7	Register predictive maintenance	32
<b>5</b>	<b>Messages and data</b>	<b>33</b>
5.1	Outside temperature	33
5.2	Energy consumption	33
5.3	Installer details	33
5.4	Appliance data	33
5.5	Technical information	34
5.6	Error messages overview	34
5.7	Service message	35
5.8	Sending error information to manufacturer	35
<b>6</b>	<b>Installation</b>	<b>37</b>
6.1	System overview	37
6.1.1	System with gateway	37
6.2	Standard delivery	37
6.3	Preparation	37
6.4	Installation of the gateway	38
6.5	Location of the Wi-Fi Thermostat	38
6.6	Installation of the Wi-Fi Thermostat	38
6.7	Setup procedure	39
6.8	Software update	39
<b>7</b>	<b>Troubleshooting</b>	<b>40</b>
7.1	Error messages	40
7.2	Other problems or questions	40
<b>8</b>	<b>Maintenance</b>	<b>41</b>
8.1	Cleaning	41
<b>9</b>	<b>Appendix</b>	<b>42</b>
9.1	Terms and conditions	42
9.2	Disposal	42
9.3	Technical specifications	42
9.4	ErP information	43
9.4.1	Product fiche	43

# 1 Manual menu

Fig.1 Introduction



AD-3001023-01

## Introduction

This chapter introduces you to the thermostat. You will find basic information, e.g. how to use the rotary dial and buttons plus how to interpret the information on the screen.

➔ Chapter: Introduction, page 5

Fig.2 General use



AD-3001024-01

## General use

This chapter helps you with the daily use of the thermostat. You will find instructions for daily use like how to change temperatures in different modes, changing control modes.

➔ Chapter: General use, page 12

Fig.3 Customisation

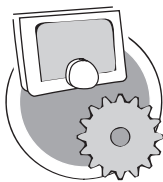

AD-3001025-01

## Customisation

This chapter helps you with customising the thermostat.

➔ Chapter: Customisation, page 20

Fig.4 Messages and data

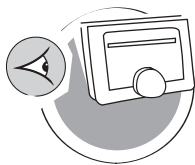

AD-3001026-01

## Messages and data

This chapter helps you with navigating to information and data of the thermostat and system.

➔ Chapter: Messages and data, page 33

Fig.5 Installation

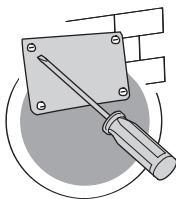

AD-3001027-01

## Installation

This chapter helps you with the installation and commissioning of the thermostat.

➔ Chapter: Installation, page 37

Fig.6 Troubleshooting

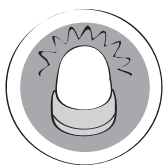

AD-3001028-01

## Troubleshooting

This chapter helps you when there is a problem with the thermostat, an error message will appear on the home screen.

➔ Chapter: Troubleshooting, page 40

Fig.7 Appendix



AD-3001029-01

## Appendix

This chapter gives you more technical information about the thermostat.

➔ Chapter: Appendix, page 42

## 2 Introduction



AD-3001023-01

This chapter introduces you to the thermostat. You will find basic information, e.g. how to use the rotary dial and buttons plus how to interpret the information on the screen.

→ Next chapter: General use, page 12

🏠 First chapter: Manual menu, page 4

### 2.1 Symbols used in the manual

This manual contains special instructions, marked with specific symbols. Please pay extra attention when these symbols are used.



#### Warning

Risk of dangerous situations that may result in minor personal injury.



#### Caution

Risk of material damage.



#### Important

Please note: important information.



#### See

Reference to other manuals or pages in this manual.

### 2.2 Introducing the Wi-Fi Thermostat

**Intended use.** The Wi-Fi Thermostat is designed as a modulating room thermostat with which you can control your heating and cooling system in an efficient way. It has a cable connection to the appliance. You can connect it to the internet via a wi-fi connection, so you can operate the thermostat with an app on your mobile device.



#### Warning

Do not use the thermostat for systems that are not in accordance with the intended use.

**A simple user interface.** You scroll through menus, select and enter options and confirm changes. The thermostat has only two buttons that you can either short-press or long-press. There is one rotary dial to scroll up or down in the menu. It's as easy as that!

**Controlling the temperature.** Your plans change. No problem, control the temperature as you wish, in manual mode or schedule mode. You can even be flexible by switching between three schedules. Do you prefer using your mobile device anywhere in the house or outside? The app is available for iOS and Android.

**What do I do when I ...? I want to ...? How do I ...?** Are you going away for a holiday? Do you want to make a fire in your fireplace? Do you need a hot water boost? Or do you want a short temperature change? You can find most answers in the "General use" chapter.



#### For more information, see

General use, page 12

## 2.3 The Wi-Fi Thermostat and its app

Fig.8

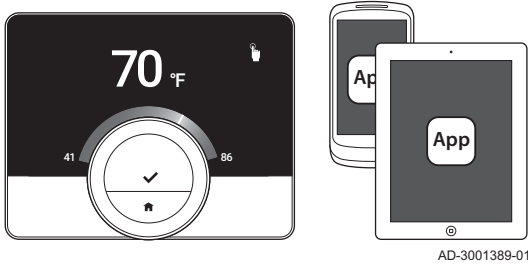

The climate in your home contributes to your comfort; with the Wi-Fi Thermostat you can control the temperature in your home the way you want it.

If you prefer to control your climate with your mobile device (e.g. smartphone or tablet) you can download the Wi-Fi Thermostat app and connect it with your thermostat. You can also connect your home automation application with the thermostat.



**Important**

The thermostat needs a reliable connection with other devices (e.g. appliance, wi-fi router) in your home.

## 2.4 What's new for the Wi-Fi Thermostat

This document is based on software version 1.56 for the Wi-Fi Thermostat which contains two minor changes:

- The zone function of the thermostat has changed.
- Some language issues have been solved.

A cleaning instruction has been added to the manual.

## 2.5 How to use the Wi-Fi Thermostat

Before you can use the thermostat, it first needs to be installed.



**For more information, see**

Installation, page 37

### 2.5.1 Using the rotary dial and buttons

Fig.9

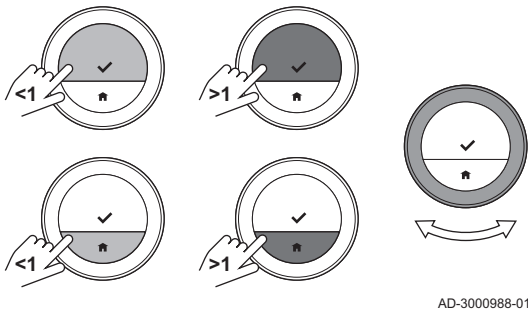

The rotary dial has two buttons: the top button is the select button, the bottom button is the home button. Pressing a button for a shorter or longer time will start different actions, as shown in this manual.

- **Short button press:** Press less than a second on the button (<1).
- **Long button press:** Press longer than a second on the button (>1).
- **Rotary dial:** Turn the rotary dial to choose and adjust menus, submenus and settings.

### 2.5.2 Entering the main menu and menu items

Fig.10

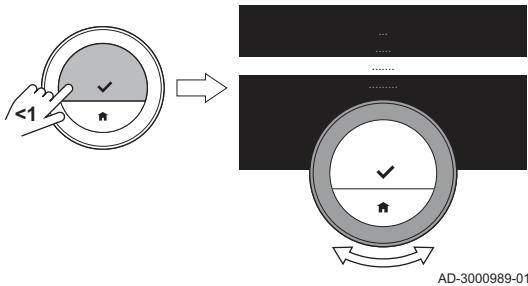

The main menu gives you access to all submenus and settings.

- Short-press the select button to enter the main menu from the home screen.
- Turn the rotary dial forward or backward to select a menu item.
- Short-press the select button to confirm the selection.

Fig.11

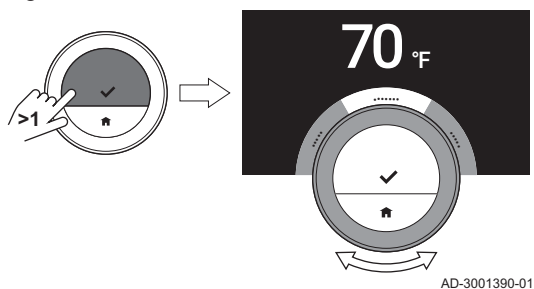

AD-3001390-01

### 2.5.3 Entering the Quick Access menu and menu items

The Quick Access menu gives you access to a selection of menu items.

- Long-press the select button to enter the Quick Access menu from the home screen.
- Turn the rotary dial forward or backward to select a menu item.
- Short-press the select button to confirm the selection.

### 2.5.4 Returning to the previous step or home screen

You can return to the previous step of the menu or return immediately to the home screen.

1. Short-press the home button to return to the previous step.

Fig.12

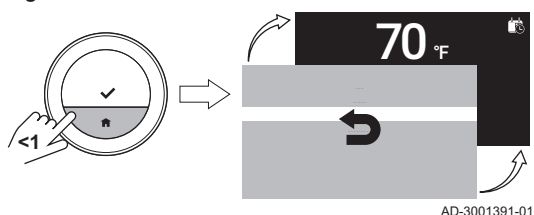

AD-3001391-01

Fig.13

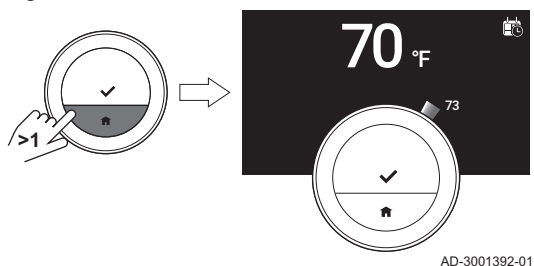

AD-3001392-01

2. Long-press the home button to return to the home screen.

### 2.5.5 Scrolling through menu items and changing settings

With the rotary dial you can scroll through menu items and change values, temperatures and time settings.

1. Turn the rotary dial to scroll through the menu items.
2. Select the menu item you want to change.
3. Short-press the select button to confirm the selection.
4. Turn the rotary dial to scroll through the submenu items.
5. Select the submenu item you want to change.
6. Short-press the select button to confirm the selection.

Fig.14

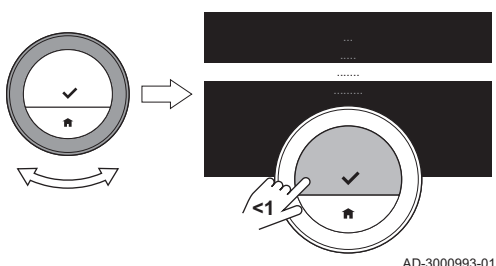

AD-3000993-01

Fig.15

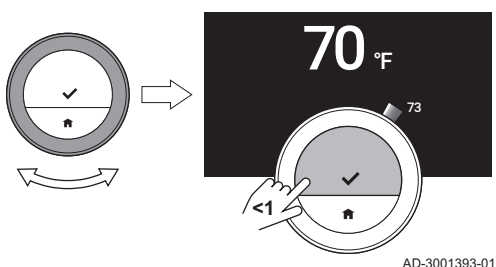

AD-3001393-01

7. Turn the rotary dial to change the setting.
8. Short-press the select button to confirm the selection.

Fig.16

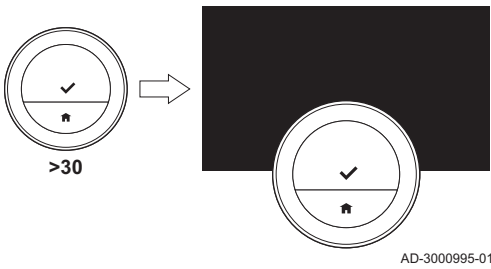

### 2.5.6 Screen shows no information

The display turns black when for 30 seconds:

- the rotary dial is not operated,
- the select button is not operated,
- the home button is not operated, and
- no person moves in front of the thermostat.

After these 30 seconds the display is black, but the thermostat is still active and no information is lost.

If the thermostat is not operated for 3 minutes in total, it goes in stand-by mode. Any unconfirmed setting or selection is lost now.

**i Important**

- Press a button, turn the rotary dial or use the presence sensor to activate the display.
- The thermostat will display the home screen after activation.
- On delivery the presence sensor is active. You can switch off the presence detection.

**For more information, see**  
Presence sensor, page 22

## 2.6 Description of the display

Fig.17

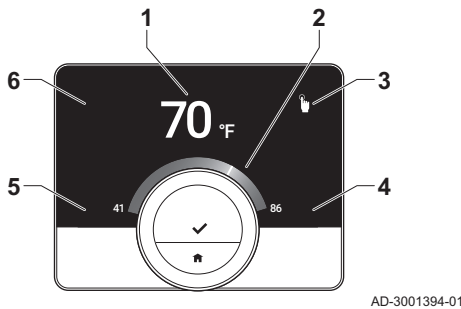

- 1 Current temperature (or target temperature)
- 2 Temperature scale
- 3 Control mode icon
- 4 Main screen information box
- 5 Main screen information box
- 6 Zone icon or Error icon

The temperature scale in the main screen shows the difference between the current and target temperature. The white line represents the current temperature. The target temperature is displayed in small digits next to the scale. The temperature scale is visible when the current temperature differs from the target temperature.

**i Important**  
The thermostat displays the current temperature in a large font by default. You can change the display of the temperature to show the target temperature.

**For more information, see**  
Screen shows no information, page 8  
Main screen setting, page 22  
Changing the display settings, page 24











### 2.6.1 Description of the icons in the display

Possible icons in the display (the display shows an icon only if your installation is fit for the related function).

















Tab.1 Control mode icons

	<p>Manual mode: Manual mode is active</p>	<p><b>See</b> Changing the mode quickly, page 12 Changing the temperature in manual mode, page 12</p>
	<p>Frost protection mode: frost protection mode is active</p>	<p><b>See</b> Changing the mode quickly, page 12 Activating frost protection mode, page 18</p>



	Holiday period: Holiday period is active	 <b>See</b> Changing the mode quickly, page 12 Setting a holiday schedule, page 16
	Fireplace mode: Fireplace mode is active	 <b>See</b> Changing the mode quickly, page 12 Activating fireplace mode, page 18
	Temperature scheduling: Temperature scheduling is active	 <b>See</b> Changing the mode quickly, page 12 Creating a temperature schedule to control the room temperature, page 13
	Short temperature change: Scheduling mode is interrupted for a short temperature change	 <b>See</b> Changing the mode quickly, page 12 Changing the temperature for a short period in scheduling mode, page 13
	Rotary dial: You are turning the rotary dial to set the temperature	 <b>See</b> Changing the temperature in manual mode, page 12 Changing the temperature for a short period in scheduling mode, page 13





Tab.2 Main screen icons

	Date	 <b>See</b> • Setting the date and time, page 21 • Main screen setting, page 22
	Time	 <b>See</b> • Setting the date and time, page 21 • Main screen setting, page 22
	Outdoor temperature	 <b>See</b> • Main screen setting, page 22 • Outside temperature, page 33
	Boiler status: Heating demand	 <b>See</b> Main screen setting, page 22
	Boiler status: Heating active	 <b>See</b> Main screen setting, page 22
	Appliance mode: On	 <b>See</b> • Switching the central heating on/off, page 18 • Main screen setting, page 22
	Appliance mode: Off	 <b>See</b> • Switching the central heating on/off, page 18 • Main screen setting, page 22
	Appliance mode: Auto	 <b>See</b> • Switching to auto mode, page 0 • Main screen setting, page 22

Tab.3 Zone icons

	Basement	 <b>See</b> Changing the name of a zone, page 24
	Bedroom	 <b>See</b> Changing the name of a zone, page 24
	Kitchen	 <b>See</b> Changing the name of a zone, page 24
	Living room	 <b>See</b> Changing the name of a zone, page 24
	Study	 <b>See</b> Changing the name of a zone, page 24
	Swimming pool	 <b>See</b> Changing the name of a zone, page 24
	Generic	 <b>See</b> Changing the name of a zone, page 24

Tab.4 Error icon

	Error display: The appliance reports an active error	 <b>See</b> Error messages overview, page 34 Troubleshooting, page 40
	Error display: The thermostat has no internet connection	 <b>See</b> Wi-Fi Thermostat connections, page 25

## 2.6.2 Customising the main screen display

You can configure the main screen of the display by adding two information boxes on the screen, one to the left and one to the right of the rotary dial.

The information boxes can show:

- Time and date
- Detailed information about your system

You can also change the display of the temperature to show the current or target temperature.



**For more information, see**

Main screen setting, page 22

Display current or target temperature, page 22

## 2.7 Messages on the display

The display of the thermostat can show several messages:

Tab.5 Messages on the display

Message	Meaning
Help message	The display can show a help message after you change to a different mode. The message informs you about the use of the quick access menu.
Service message	The display shows a service message when the appliance needs maintenance.
Error message	The display shows an error message when the appliance has an error.

**Important**

The error code in the error message comes from the appliance.

**For more information, see**

Show help messages, page 22

Service message, page 35

Error messages overview, page 34

## 2.8 Presence detection

Fig.18

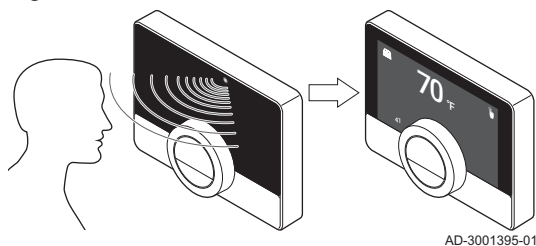

The main screen of the display will light up (for 5 seconds) if the presence sensor detects that you are in front of the thermostat or pass by. You can disable the presence sensor in the settings menu.

**For more information, see**

Presence sensor, page 22

## 2.9 Zones control

If you have multiple zones in your heating (and cooling) installation, you can control the temperature in several zones. In many installations the maximum is three zones. A zone can be a specific room or, for example a floor. If there is an thermostat in a zone, you can control this zone only with its own thermostat.

If your installation is fit for it, you can set one zone to heating and another one to cooling.

The zones are named CircA, CircB etc. by default. You can change the names on the thermostat or in the app.

**For more information, see**

Changing the name of a zone, page 24

### 3 General use



AD-3001024-01

This chapter helps you with the daily use of the thermostat. You will find instructions for daily use like how to change temperatures in different modes, changing control modes.

- ➔ Next chapter: Customisation, page 20
- ➔ Previous chapter: Introduction, page 5
- 🏠 First chapter: Manual menu, page 4

#### 3.1 Changing the mode quickly

Fig.19

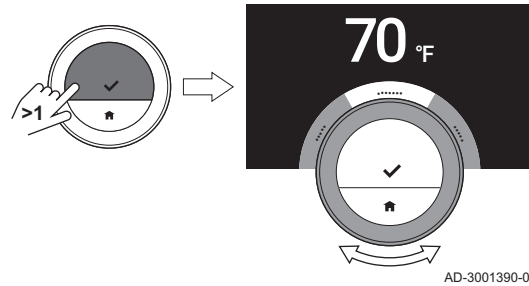

AD-3001390-01

You can change the control mode quickly from the access menu.

1. Long-press the select button to enter the Quick Access menu.
2. Turn the rotary dial to select the desired mode.
3. Short-press the select button to confirm your choice.

Tab.6 Possible mode and description

<b>Manual:</b> The room temperature can be set instantly with the rotary dial.
<b>Frost Protection:</b> The room temperature is set to the frost protection temperature setting.
<b>Holiday:</b> The room temperature is set to the holiday temperature setting.
<b>Fireplace:</b> Continue heating other rooms in the same zone while an additional heat source heats the room where the Wi-Fi Thermostat is located.
<b>Scheduling:</b> The room temperature is controlled by a temperature schedule. <sup>(1)</sup>
(1) When multiple schedules are enabled, Schedules 1 to 3 are shown.



**For more information, see**

- Changing the temperature in manual mode, page 12
- Changing the temperature for a short period in scheduling mode, page 13
- Setting a holiday schedule, page 16
- Activating fireplace mode, page 18
- Activating frost protection mode, page 18

#### 3.2 Changing the room temperature

Fig.20

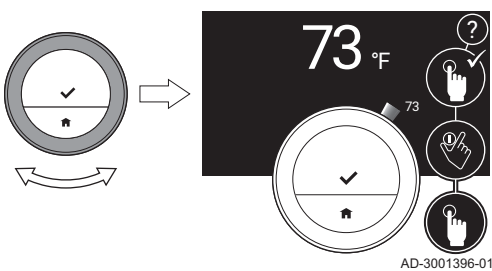

AD-3001396-01

##### 3.2.1 Changing the temperature in manual mode

In manual mode you can easily change the room temperature.

1. Check that the thermostat operates in manual mode (see icon in top-right corner of main screen).
2. Turn the rotary dial to change the temperature.
  - ⇒ While you turn the rotary dial, the target temperature is displayed in light digits. After a few seconds, the thermostat shows the home screen again with the current temperature (or target temperature) in bold digits.



**Important**

When the thermostat is in manual mode, only a scheduled holiday period can automatically change the room temperature.

Fig.21

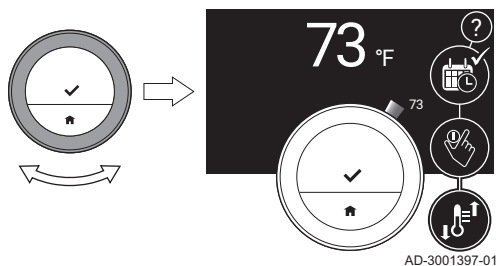

### 3.2.2 Changing the temperature for a short period in scheduling mode

You can change the temperature for a short set period when the thermostat is in scheduling mode. At the end of the period the thermostat will return to the scheduled temperature.

1. Check that the thermostat operates in scheduling mode: see the icon in the top-right corner of the main screen.
2. Change the temperature with the rotary dial.  
⇒ The display shows the selected temperature and the end time (max 24 hours from now).
3. Long-press the select button if you want to change the end time.
4. Change the period between 0 and 24 hours.



#### Important

If you change it to 0 hours, the short temperature change is deleted.

5. Confirm the change.



#### Important

You can delete the set temperature change by selecting **Clear Short Temperature Change** in the main menu.

## 3.3 Creating a temperature schedule to control the room temperature

A temperature schedule enables you to change the target temperature at any moment that you choose. You can set a different schedule for each day of the week.

You can customise each day schedule to your own preference:

- Change the switch time.
- Choose another activity between two switch times.
- Change the temperature of an activity.
- Add up to a maximum of 6 switch times per day.
- Remove switch times to a minimum of none (resulting in constant temperature all day long based on the last activity from the previous day).

You can create up to three week schedules. For example, you can create time schedules for:

- A week with normal working hours.
- A week with different working hours.
- A week when you are at home most of the time.

### 3.3.1 Changing the weekdays of a temperature schedule

You can change, add or delete temperature intervals in one or more weekdays of a timer program. For example, you can lower the temperature during the night and when you are out of the house. You can set the switch point and the activity (with its temperature) for each interval of the schedule.

1. Enter the main menu.
2. Select
  - **Change Schedule**
  - **Change Heating Schedule**



#### Important

The display shows these options only if your installation is fit for them.

3. If multiple schedules is enabled: Select **Schedule 1**, **Schedule 2** or **Schedule 3**.

Fig.22

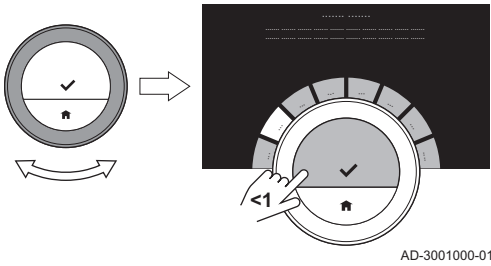

4. Select and confirm the day(s) that you want to program.



**Important**

- When you select more than one day, the days will be assigned the same day schedule.
- Help text on the display above the schedule helps you perform changes.

Fig.23

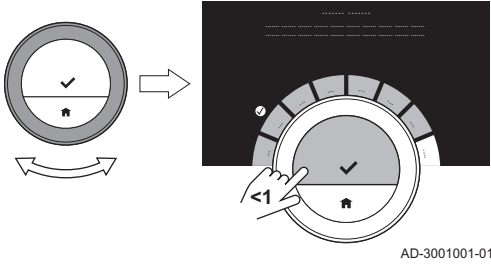

5. Confirm the selected day(s) by rotating the rotary dial to **DONE** and pressing the select button.  
 6. Change, add or delete activities and switch times.



**Important**

You can short-press the home button to go back one step.

■ **Changing an activity**

The temperature of a time interval in the day schedule is set by the selected activity. By changing the activity another target temperature is set.



**Important**

When you change an activity the cursors mark the item you are changing.

1. Select the activity with the rotary dial.
2. Confirm the selection.
3. Choose a different activity with the rotary dial or leave it as is.
4. Confirm the selection.
5. Change the temperature of the activity or leave it as is.

Fig.24

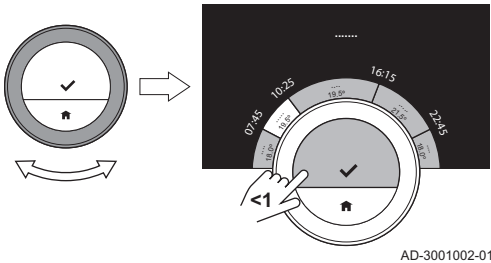

**Important**

- The temperature you set for an activity is the same for every day of the week where you use this activity.
- The **Custom** activity, however, can have a different temperature on each day of the week.

6. Confirm the selection.



**For more information, see**

Changing the name of an activity, page 23

■ **Changing a switch time**

The switch time is the start time of new activity interval in the day schedule.



**Important**

When you change a switch time the cursors mark the item you are changing.

1. Select the switch time with the rotary dial.
2. Confirm the selection.
3. Change the switch time.
4. Confirm the selection.

Fig.25

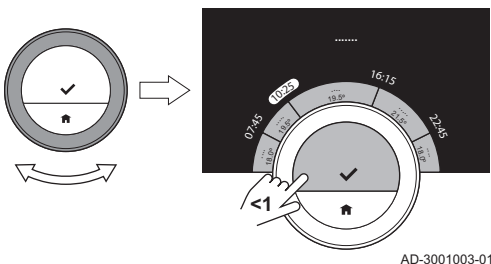
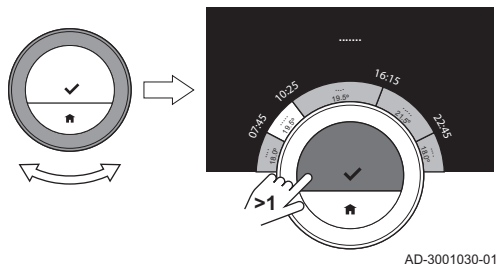
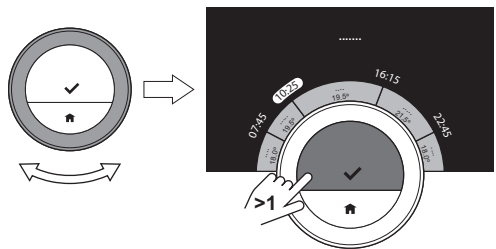

Fig.26



AD-3001030-01

Fig.27



AD-3001031-01

### ■ Adding or deleting activities and switch times

You can add or remove activity intervals from the day schedule.

1. Select an activity and long-press the select button to add an interval.  
⇒ An new interval is created within the start and end time of the existing activity interval.
  2. Repeat step 1 to add more intervals, if required.
  3. Change the activity of the new interval(s).
  4. Change the switch time of the new interval(s), if required.
5. Select a switch time and long-press the select button to delete an interval.
  6. Select **DONE** using the rotary dial to save the day schedule.

### 3.3.2 Copying a weekday of a temperature schedule

You can copy the schedule of one weekday to other weekdays, to speed up the creation of a temperature schedule.

1. Enter the main menu.
2. Select
  - **Change Schedule**
  - **Change Heating Schedule**



#### Important

The display shows these options only if your installation is fit for them.

3. If multiple schedules is enabled: Select **Schedule 1**, **Schedule 2** or **Schedule 3**.
4. Select the weekday you want to copy.
5. Confirm the selected day(s) by rotating the rotary dial to **DONE** and pressing the select button.  
⇒ The day schedule is opened.
6. Select **Copy** using the rotary dial.
7. Confirm the selection.  
⇒ The week schedule is opened.
8. Select and confirm the weekday(s) on which you want to copy the day schedule.
9. Confirm the selected day(s) by rotating the rotary dial to **DONE** and pressing the select button.  
⇒ The day schedule is copied to the selected day(s).

### 3.3.3 Selecting another temperature schedule

Your weekly programme can differ from week to week. The thermostat offers you three possible schedules to program. You can set which temperature schedule is active. First you have to enable the use of multiple schedules.

1. Enter the main menu.
2. Select **Settings**.
3. Select **Enable multiple schedules**.
4. Enter the main menu.
5. Select **Select Active Temperature Schedule**.
6. Select **Schedule 1**, **Schedule 2** or **Schedule 3**.

7. Confirm the selection.
  - ⇒ The selected temperature schedule becomes active, which is shown by the icon in the top-right corner of the main screen.

### 3.4 Setting a holiday schedule

When you will be away for a longer period you can decrease the room temperature to save energy. The holiday mode temperature overrules the temperature(s) set in scheduling mode or manual mode.

#### 3.4.1 Creating a holiday schedule

You can create a holiday schedule via the main menu or via the quick access menu.

##### ■ Creating a holiday schedule via the main menu

1. Enter the main menu.
2. Select **Input Holiday Period**.
3. Confirm the selection.
4. Set the starting date and end date of the holiday period:
  - 4.1. Select an item.
  - 4.2. Confirm the selection.
  - 4.3. Turn the rotary dial to change the item.
  - 4.4. Confirm the change.
5. Set the room temperature for the holiday period:
  - 5.1. Turn the rotary dial to select **Temperature**.
  - 5.2. Confirm the selection.
  - 5.3. Turn the rotary dial to change the temperature.
  - 5.4. Confirm the change.
    - ⇒ The display shows: **Holiday period set**.
    - The display shows the holiday icon in the top right corner of the main screen when the holiday period starts.



##### Important

The heating device in your installation determines what is the minimum temperature for the holiday period.

- 5.4. Confirm the change.
  - ⇒ The display shows: **Holiday period set**.
  - The display shows the holiday icon in the top right corner of the main screen when the holiday period starts.



##### Important

The holiday mode can also be set for any other appliance in your installation, such as a hot water generator.

##### ■ Creating a holiday schedule via the quick access menu

1. Long-press the Select button.
2. Select **Holiday**.
3. Confirm the selection.
4. Set the starting date and end date of the holiday period:
  - 4.1. Select an item.
  - 4.2. Confirm the selection.
  - 4.3. Turn the rotary dial to change the item.
  - 4.4. Confirm the change.

Fig.28

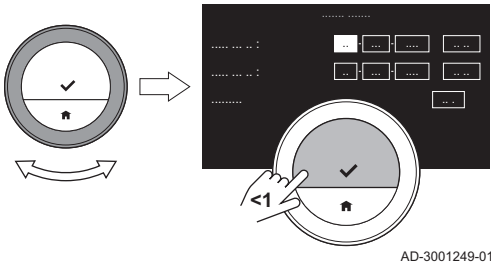



5. Set the room temperature for the holiday period:
  - 5.1. Turn the rotary dial to select **Temperature**.
  - 5.2. Confirm the selection.
  - 5.3. Turn the rotary dial to change the temperature.

**Important**

The heating device in your installation determines what is the minimum temperature for the holiday period.

- 5.4. Confirm the change.
  - ⇒ The display shows: **Holiday period set**.

**Important**

The holiday mode can also be set for any other appliance in your installation, such as a hot water generator.

### 3.4.2 Changing a holiday schedule

---

You can change the holiday schedule via the main menu and via the quick access menu..

#### ■ Changing the holiday schedule via the main menu

1. Enter the main menu.
2. Select **Input Holiday Period**.
3. Confirm the selection.
4. Select **Edit**.
5. Confirm the selection.
6. Change the period and/or temperature.
7. Select **Save**.
8. Confirm the change.

#### ■ Changing the holiday schedule via the quick access menu

1. Long-press the Select button to enter the quick access menu.
2. Select **Holiday**.
3. Confirm the selection.
4. Select **Edit**.
5. Confirm the selection.
6. Change the period and/or temperature.
7. Select **Save**.
8. Confirm the change.

### 3.4.3 Deleting a holiday schedule

---

You can delete the holiday schedule via the main menu and via the quick access menu.

#### ■ Deleting the holiday schedule via the main menu

1. Enter the main menu.
2. Select **Input Holiday Period**.
3. Confirm the selection.
4. Turn the rotary dial to the left to select **Clear**.
5. Confirm the selection.

#### ■ Deleting the holiday schedule via the quick access menu

1. Long-press the Select button to enter the quick access menu.
2. Select **Holiday**.
3. Confirm the selection.
4. Turn the rotary dial to the left to select **Clear**.
5. Confirm the selection.

### 3.5 Activating fireplace mode

Fireplace mode enables you to continue heating other rooms that are controlled by your system while another heat source heats the room where the thermostat is. For instance a fire lighted in your fireplace or a large number of people can heat the room so much, that the appliance stops heating all the rooms.

**i Important**  
 Activate the Fireplace mode before the other heat source becomes active.

1. Enter the main menu.
2. Select **Enable Fireplace**.
3. Confirm the selection.  
 ⇒ The fireplace icon appears in the top right corner of the main screen.

**i Important**  
 You can switch off fireplace mode by selecting **Disable Fireplace** in the main menu.

### 3.6 Activating frost protection mode

You can activate the frost protection mode for central heating and domestic hot water production, when you will be out of the house in winter for a longer period of time. The heating system will keep the temperature just high enough to avoid frost damage and thus save the maximum amount of energy.

**! Caution**  
 Freezing can still occur in rooms that are not heated. Open all radiators and zones of the central heating system to prevent freezing.

Fig.29

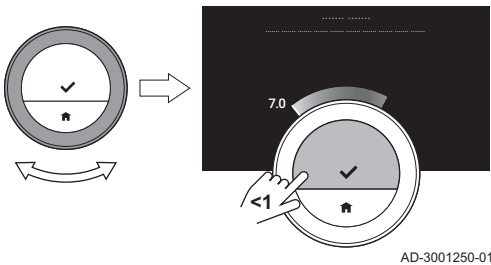

1. Enter the main menu.
2. Select **Enable Frost Protection**.
3. Confirm the selection.  
 ⇒ The display shows a message that you can change the frost protection temperature.
4. Long-press the select button while the message is visible.
5. Turn the rotary dial to change the temperature.

**i Important**  
 The appliance in your installation determines what is the minimum temperature for the antifrost mode.

6. Confirm the change.  
 ⇒ The frost protection mode is on and the display shows the frost protection icon in the top right corner of the main screen.

**i Important**

- In frost protection mode you cannot change the room temperature. If you try to do so, the display shows a message.
- You can deactivate the frost protection mode by selecting **Enable Manual Mode** or **Enable Temperature Scheduling**.

### 3.7 Switching the central heating on/off

You can switch off the central heating function of the installation, to save energy during e.g. the summer period.

If heating is switched off, the appliance will continue providing hot tap water (if your installation is fit for it).

1. Enter the main menu.
2. Select **Operating mode**.
3. Select and confirm **Off** to switch off the heating function.

4. Select and confirm **On** to switch the heating function on again.

## 4 Customisation

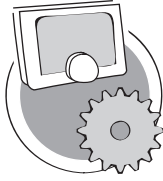

AD-3001025-01

This chapter helps you with customising the thermostat.

→ Next chapter: Messages and data, page 33

← Previous chapter: General use, page 12

🏠 First chapter: Manual menu, page 4

### 4.1 Hot water settings

#### **i** Important

- The hot water settings can only be changed for combi appliances. An appliance that can produce both central heating water and hot tap water.
- This menu item is not available for appliances with an on/off communication protocol.

#### 4.1.1 Changing the hot water temperature

If you want to change the maximum temperature of the hot tap water, you have to change the hot water setpoint.

1. Enter the main menu.
2. Select **Hot Water**.
3. Select the option **Hot water setpoint**.
4. Use the rotary dial to change the hot tap water temperature.
5. Confirm the selection.

#### 4.1.2 Setting the hot water comfort mode

If you need hot water immediately when you open the hot water tap, you can select the comfort setting. The appliance permanently keeps the tap water heated, even when you are not using the taps.

1. Enter the main menu.
2. Select **Hot Water**.
3. Select **Enable permanent comfort**.
4. Confirm the selection.

#### 4.1.3 Setting the hot water reduced (energy-saving) mode

If you want to save energy, you can set the appliance to the hot water energy-saving mode. The appliance will only start heating tap water when you open the hot tap. In this case it will take more time before the tap water reaches the maximum temperature.

The energy saving mode can be active permanently or at scheduled times.

1. Enter the main menu.
2. Select **Hot Water**.
3. Select **Enable permanent reduced** to activate the energy-saving mode permanently.
4. Select **Enable scheduling** to activate the energy-saving mode at scheduled times.
5. Confirm the selection.

#### 4.1.4 Changing the hot water schedule

In the hot water schedule you can set at which times the appliance must deliver hot water in comfort mode or reduced mode. In comfort mode hot water is delivered immediately, in reduced mode you have to wait shortly. You can set the comfort mode during periods when you need hot water immediately (e.g. for taking a shower or bath) and the reduced mode to save energy during periods when you don't need hot water (immediately).

1. Enter the main menu.
2. Select **Hot Water**.
3. Select **Change hot water scheduling**.
4. Select and confirm the day(s) that you want to program.

**Important**

- When you select more than one day, the days will be assigned the same day schedule.
- Help text on the display above the schedule helps you perform changes.

5. Confirm the selected day(s) by rotating the rotary dial to **DONE** and pressing the select button.
6. Create the day schedule with the switching times and hot water settings (comfort or reduced).
7. Confirm the selection.
8. Copy the schedule to other weekdays, if required.

**Important**

- You can change the hot water schedule in a similar way to the temperature schedules for heating.

**For more information, see**

- Creating a temperature schedule to control the room temperature, page 13

Fig.30

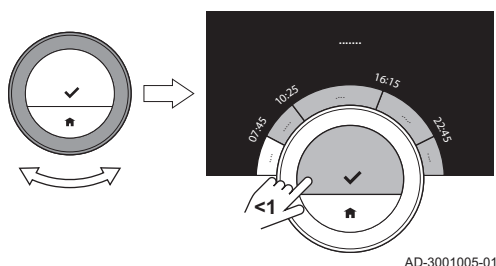

AD-3001005-01

## 4.2 Wi-Fi Thermostat settings

### 4.2.1 Setting the date and time

When you start up the thermostat for the first time, you enter automatically the menu to set the time and date.

You enter this menu also when there has been a power outage and the thermostat has no internet connection.

During normal operation you can change the date and time settings by navigating to the menu.

1. Enter the main menu.
2. Select **Settings**.
3. Confirm the selection.
4. Select **Date time settings**.
5. Confirm the selection.
6. Select **Date time**.
7. Confirm the selection.
8. Change the date and time setting.
9. Confirm the change.

Fig.31

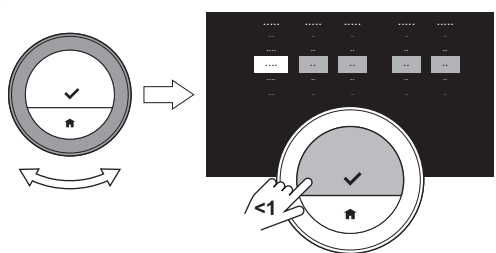

AD-3001251-01

### 4.2.2 Setting country and language

You select the country where you are and the language for the text on your display.

You select your time zone as well.

When you start up the thermostat for the first time, you enter automatically the menu to set the country and language.

During normal operation of the thermostat you can change the country and language settings at a later moment by navigating to the menu.

1. Enter the main menu.
2. Select **Settings**.
3. Confirm the selection.
4. Select **Country and language**.
5. Confirm the selection.
6. Select your country.
7. Confirm the selection.
8. Select your language.

9. Confirm the selection.
10. Select your time zone.
11. Confirm your selection.

#### 4.2.3 Main screen setting

You can add two information boxes on the main screen, one to the left and one to the right of the rotary dial.

1. Enter the main menu.
2. Select **Settings**.
3. Select **Main screen settings**.
4. Use the rotary dial to select the left information box.
5. Select one of the options.
6. Confirm the selection.
7. Use the rotary dial to select the right information box.
8. Select one of the options.
9. Confirm the selection.



#### Important

You can short-press the home button to go back one step.

Fig.32

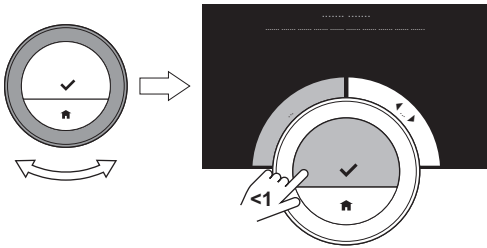

AD-3001006-01

#### 4.2.4 Show help messages

When you have just started to use the thermostat, the display shows a help message after you change to a different mode. The message informs you about the use of the quick access menu. The display will stop showing these messages after some time.

If you wish to see the messages again:

1. Enter the main menu.
2. Select **Settings**.
3. Confirm the selection.
4. Select **Show help messages**.
5. Confirm the selection.
  - ⇒ The display shows **Show help messages enabled** and the help messages will appear again for some time.

#### 4.2.5 Presence sensor

The thermostat has a sensor for presence detection. When you pass by or approach the thermostat, the main screen of the display will light up for 5 seconds. This setting is on by default.

You can switch off the presence detection.

1. Enter the main menu.
2. Select **Settings**.
3. Select **Presence sensor detection**.
4. Select **Off**.
5. Confirm the selection.



#### Important

- With the presence sensor switched off you need to press a button or turn the rotary dial to activate the display. The main screen of the display will light up for 30 seconds.
- Set **Presence sensor detection** to **On** to activate the presence sensor again.

Fig.33

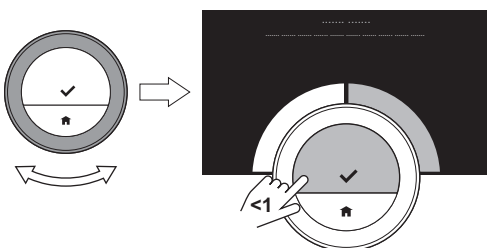

AD-3001007-01

#### 4.2.6 Display current or target temperature

The thermostat displays the current temperature in a large font by default. The target temperature is in a small font near the temperature scale.

Fig.34

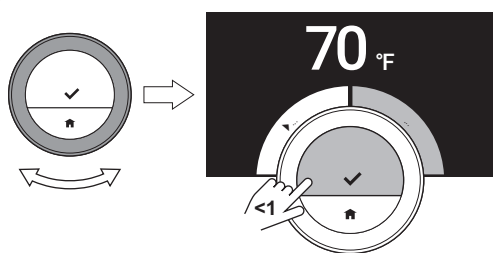

AD-3001399-01

You can change the display of the temperature to show the target temperature in large font and the current temperature in a small font.

1. Enter the main menu.
2. Select **Settings**.
3. Select **Display current or target temperature**.
4. Select **Current Temperature** or **Target Temperature**.
5. Confirm the selection.

This setting will stay until you change this setting again or reset the thermostat to factory settings.



#### Important

The instructions in this manual are based on the default setting for current temperature. Changing the display of the temperature influences the instructions given.

### 4.2.7 Child lock

The Wi-Fi Thermostat has a child lock that can be activated to prevent children changing the settings like the target temperature.

#### ■ Activating the child lock

1. Enter the main menu.
2. Select **Settings**.
3. Confirm the selection.
4. Select **Enable child lock**.
5. Confirm the selection.
  - ⇒ The display shows **Child lock enabled**. The screen will be locked when the display of the thermostat goes in stand-by mode.
6. Short-press a button or turn the rotary dial to reactivate the display.
  - ⇒ The display shows **Screen locked**.



#### Important

The child lock can also be used to prevent unwanted access to the thermostat in public buildings.

#### ■ Deactivating the child lock

1. Press the select button for more than 5 seconds to unlock the screen.
  - ⇒ The display shows **Screen unlocked**.
2. Enter the main menu.
3. Select **Settings**.
4. Confirm the selection.
5. Select **Disable child lock**.
6. Confirm the selection.
  - ⇒ The display shows **Child lock disabled**. The screen is permanently unlocked.

### 4.2.8 Changing the name of an activity

You can change the names of the activities for the temperature schedules. The default activity names are dependant on the appliance in your installation.



#### Important

The **Custom** activity can be set to a different temperature on each day of the week.

1. Enter the main menu.
2. Select **Settings**.
3. Confirm the selection.
4. Select **Change Activity Name**.
5. Confirm the selection.
6. Select the name you want to change.
7. Confirm the selection.

Fig.35

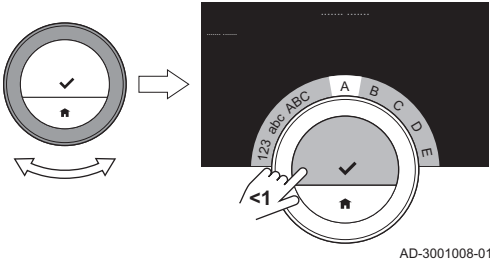

8. Change the name:
  - 8.1. Select the backspace ← in the character selection menu.
  - 8.2. Confirm the selection to delete the character.
  - 8.3. Delete more characters until you can start with the new name.
  - 8.4. Select ⏪ in the character selection menu.
  - 8.5. Confirm the selection to add a space to the name.
  - 8.6. Select a character for the new name.
  - 8.7. Confirm the selection to add the character to the name.
  - 8.8. Add more characters until you finish the name.

Fig.36

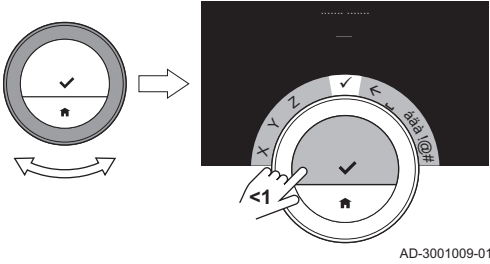

9. Select ✓ in the character selection menu.
10. Confirm to save the new name.

### 4.2.9 Changing the name of a zone

You can change the names of the zone(s) of your heating system.

1. Enter the main menu.
2. Select **Settings**.
3. Confirm the selection.
4. Select **Change %1Zone friendly Name**.
5. Confirm the selection.
6. Select the zone name you want to change.
7. Confirm the selection.
8. Change the name:
  - 8.1. Select the backspace ← in the character selection menu.
  - 8.2. Confirm the selection to delete the character.
  - 8.3. Delete more characters until you can start with the new name.
  - 8.4. Select ⏪ in the character selection menu.
  - 8.5. Confirm the selection to add a space to the name.
  - 8.6. Select a character for the new name.
  - 8.7. Confirm the selection to add the character to the name.
  - 8.8. Add more characters until you finish the name.
9. Select ✓ in the character selection menu.
10. Confirm to save the new name.

Fig.37

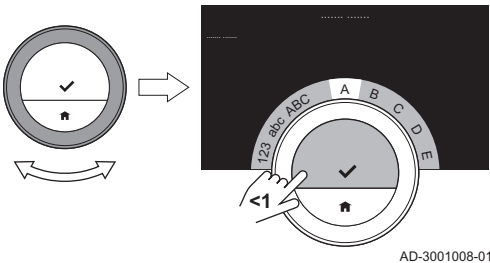
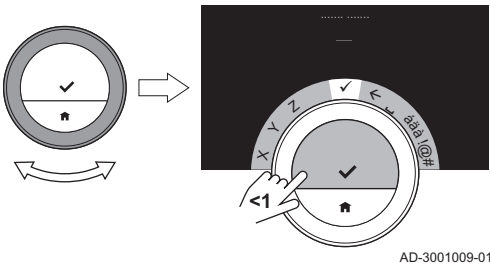

Fig.38



**Important**

You can choose another zone icon for the thermostat with the app on your mobile device.

### 4.2.10 Changing the display settings

You can change the screen brightness and click sound of the rotary dial of the display.

■ **Changing the display brightness**

You can change the brightness of the display. The brightness can be set to any value between 10% and 100%.

1. Enter the main menu.
2. Select **Settings**.
3. Select **Set Display Brightness:**



4. Choose a brightness level between 10% and 100% using the rotary dial.
5. Confirm the setting.

#### ■ Turning the click sound on/off

When you turn the rotary dial the thermostat makes a click sound at every change. You can choose to turn this click sound off (or on again).

1. Enter the main menu.
2. Select **Settings**.
3. Select **Click sound**.
4. Select **Off** or **On**.
5. Confirm the setting.

#### 4.2.11 Enabling time synchronization by internet

---

You can enable or disable the time synchronization of your thermostat with an NTP server on the internet.

1. Enter the main menu.
2. Select **Settings**.
3. Confirm the selection.
4. Select **Date time settings**.
5. Confirm the selection.
6. Select **NTP**.
7. Confirm the selection.
8. Select **On** or **Off**.
9. Confirm the setting.

#### 4.2.12 Enabling daylight saving

---

You can enable or disable automatic switching to summer time and winter time if your appliance system is fit for this option.

1. Enter the main menu.
2. Select **Settings**.
3. Confirm the selection.
4. Select **Date time settings**.
5. Confirm the selection.
6. Select **Enable daylight save**
7. Select **On** or **Off**.
8. Confirm the setting.

#### 4.2.13 Changing unit system

---

You can choose the unit system in the display: the metric system shows temperature in °C and water pressure in bar. The imperial system shows temperature in °F and pressure in psi.

1. Enter the main menu.
2. Select **Settings**.
3. Confirm the selection.
4. Select **Change unit system**.
5. Confirm the selection.
6. Turn the rotary dial to select **Metric** or **Imperial**.
7. Confirm the selection.

## 4.3 Wi-Fi Thermostat connections

---

You can operate the Wi-Fi Thermostat with the Wi-Fi Thermostat app on a mobile device or with a home automation application. This allows you to control the appliance(s) in your installation when you are not near the Wi-Fi Thermostat. You need a wi-fi network and a mobile device with Apple iOS or Android to make the connection.

### 4.3.1 Establishing the wi-fi connection

---

To be able to connect the thermostat to your mobile device, you must first connect the thermostat to your wi-fi network.

When you start up the thermostat for the first time, you enter automatically the menu to connect to your wi-fi network. Before you start to set your wi-fi connection you have to approve the **Terms and Conditions**.



**See**  
Terms and conditions, page 42

During normal operation of the thermostat you can decide to change or reconnect to your wi-fi network at a later moment.

1. Enter the main menu.
2. Select **Settings**.
3. Confirm the selection.
4. Select **Wi-fi**.
5. Confirm the selection.
6. Accept the **Terms and Conditions**.



**Important**  
The display only shows the option to accept the Terms and Conditions when you declined them or when you reset the thermostat to default settings.

7. Read the Privacy Policy.



**Important**  
The display only shows the Privacy Policy if it showed the option to accept the Terms and Conditions.

8. Select your wi-fi network in the list of available networks.
9. Confirm the selection.
10. Enter the password with the rotary dial and the select button.
11. Select ✓ in the character selection menu to confirm the password.  
⇒ The thermostat is now connected to the wi-fi network.

#### ■ Connecting the Wi-Fi Thermostat to an access point

You can connect the thermostat to an access point in your wi-fi network.

1. Select **WPS Button** in the list of available networks.



**Important**  
If you select **Back**, the display shows the previous screen.

2. Activate the **WPS** on your router (if the router has this option).  
⇒ The thermostat is now automatically connected to the access point.

#### ■ Connecting the Wi-Fi Thermostat to a hidden network

You can connect to a hidden wi-fi network, if you know the name and password.

1. Select **Other...** in the list in the list of available networks.
2. Enter the network name with the rotary dial and the select button.
3. Select ✓ in the character selection menu.
4. Confirm the selection to save the network name.
5. Select the security mode.
6. Confirm the selection.
7. Enter the password with the rotary dial and the select button.
8. Select ✓ in the character selection menu.
9. Confirm the selection to save the password.  
⇒ The thermostat is now connected to the hidden wi-fi network.

### 4.3.2 Downloading the app

---

You can install the Wi-Fi Thermostat app on your mobile device.

1. Download the free app in the App Store or Google Play. Refer to the information on the box of the thermostat.
2. Start the app and follow the instructions on your mobile device until the app requests a registration code from the thermostat.

### 4.3.3 Connecting the app with the Wi-Fi Thermostat

When you start up the thermostat for the first time, you enter automatically the menu to register your app or home automation application. You need an account based on your email address for the connection. During normal operation of the thermostat you can decide to connect or reconnect the app with the thermostat at a later moment.

1. Open the app and create an account in the settings menu.
  - ⇒ If you create a new account, you will receive an email message for confirmation.
2. Read the email message.
  - ⇒ Check your spam folder if the email does not appear in your inbox.
3. Confirm your account on the website.
4. Enter the main menu of the thermostat.
5. Select **Settings**.
6. Select **Register device or service**.
  - ⇒ The thermostat displays a registration code and QR code.
7. Enter the registration code in the app or scan the QR code with your mobile device.
8. Complete the registration process.

Fig.39

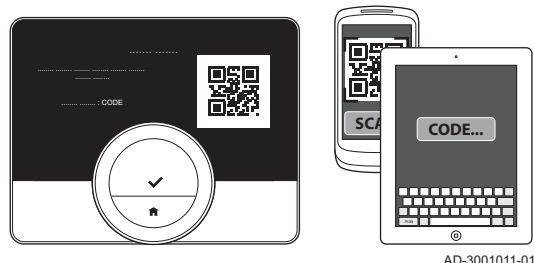

AD-3001011-01

### 4.3.4 Connecting your home automation application with the Wi-Fi Thermostat

When you start up the thermostat for the first time, you enter automatically the menu to register your app or home automation application. If your home automation application can communicate with the IFTTT protocol, you can connect it with the thermostat. You need an account based on your email address for the connection. During normal operation of the thermostat you can decide to connect or reconnect the home automation application with the thermostat at a later moment.

1. Open the home automation application and create an account for the thermostat.
2. Read the email message.
  - ⇒ Check your spam folder if the email does not appear in your inbox.
3. Confirm your account on the website of the manufacturer of the thermostat.
4. Enter the main menu of the thermostat.
5. Select **Settings**.
6. Select **Register device or service**.
  - ⇒ The thermostat displays a registration code and a QR-code.
7. Enter the registration code in the home automation application or scan the QR-code with your mobile device.
8. Complete the registration process.

### 4.3.5 Registering installer access

If you want your installer to make any changes, you can allow the installer to log in to your device.

1. Enter the main menu.
2. Select **Settings**.
3. Select **Register installer access**.
4. Confirm the installer access.
  - ⇒ This gives your installer access for up to 72 hours.

## 4.4 Advanced settings

### 4.4.1 Resetting to default settings

You can reset most of the thermostat settings to their default settings at the same time.

**i Important**

- All connection settings for communication will be deleted too!
- The temperature schedules, control mode and holiday period will not be reset.

1. Enter the main menu.
2. Select **Settings**.
3. Select **Reset to default settings**.
4. Select **Reset**.
5. Confirm the selection.
  - ⇒ The display will show 'welcome' in all languages.
6. Press the select button to continue.
  - ⇒ The setup procedure will start.

**For more information, see**  
Setup procedure, page 39

Fig.40

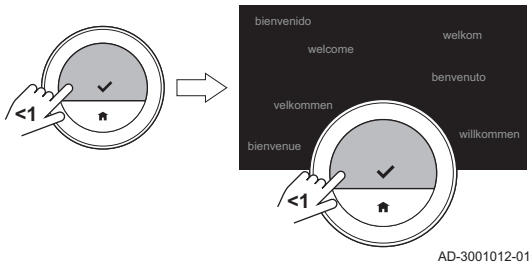

AD-3001012-01

### 4.4.2 Check for software update

If your thermostat is connected to wi-fi, the internet and the server, software will be updated automatically. You can check the status of the software:

1. Enter the main menu.
2. Select **Settings**.
3. Select **Check for software update**.
  - ⇒ The display shows the status of the software.

### 4.4.3 Temperature calibration

You can manually calibrate the temperature if the thermostat displays a temperature that does not correspond with the actual room temperature. This procedure should normally not be necessary.

1. Wait for at least 30 minutes after installation of the thermostat.
2. Measure the actual room temperature.
3. Enter the main menu.
4. Select **Settings**.
5. Confirm the selection.
6. Select **Temperature calibration**.
7. Confirm the selection.
  - ⇒ The display shows the temperature measured by the thermostat as **Temperature detected**.
8. If the detected temperature does not match with the temperature you have measured: turn the rotary dial to change the temperature at **Calibrate this temperature to**.
9. Confirm the change.

**i Important**

- It may take some time before the thermostat shows the new offset on the **Current Temperature**.
- The new offset will be used over the entire temperature range.

Fig.41

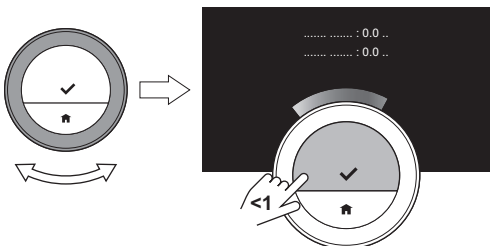

AD-3001252-01

#### 4.4.4 Activating Preheat

You can choose to preheat the room or a zone for a set period to give it a set temperature at the start time of the scheduled heating period.

1. Enter the main menu.
2. Select **Settings**.
3. Confirm the selection.
4. Select **Preheat**.
5. Confirm the selection.
6. Turn the rotary dial to change the preheat period.

**i Important**  
If you turn the rotary dial to 0 minutes, the preheat function is deactivated.

7. Confirm the change.

## 4.5 Installer settings

When you enter the Installer menu, the display shows a warning that the settings in the Installer Menu may affect the performance of your appliance. It may be a better idea that your installer does these settings.

### 4.5.1 Changing the heating curve

The heating curve relates the water temperature of the heating system to the outside temperature. With a good heating curve the installation can maintain a constant temperature in the room.

1. Enter the main menu.
2. Select **Installer**.
3. Confirm the selection.
4. Select **Yes** to continue.
5. Confirm the selection.

Fig.42

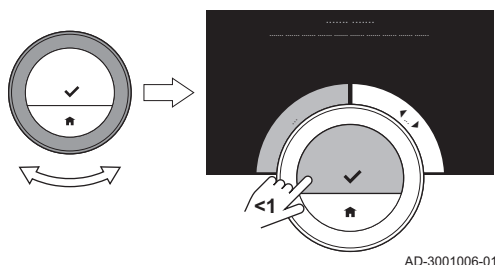
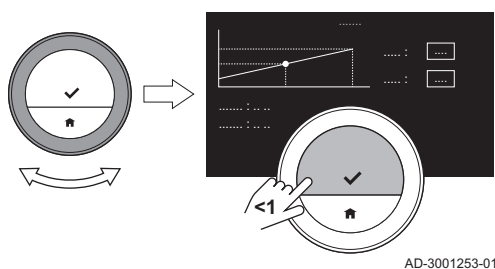

Fig.43



6. Select **Heating Curve**.

**i Important**  
The display shows **Heating Curve** only if your installation is fit for this option.

7. Confirm the selection.
  - ⇒ The display shows the heating curve diagram.
8. Short-press the select button to select the central curve point.
9. Use the rotary dial to move the central curve point over the oblique line in order to see the outside temperatures and the related water temperatures in the bottom-left corner.
10. Short-press the select button to deselect the central curve point.
11. Use the rotary dial to select **Min:** (the minimum water temperature of the appliance).
12. Confirm the selection.
13. Use the rotary dial to change the temperature.
14. Confirm the change.
15. Use the rotary dial to select **Slope:** (the steepness of the heating curve).
16. Confirm the selection.

Fig.44

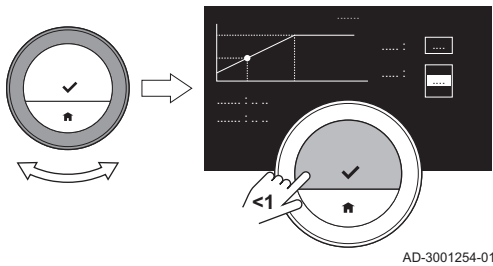

17. Use the rotary dial to change the steepness.
18. Confirm the change.
19. Use the rotary dial to select **Save** at the bottom-right corner of the display.
20. Confirm to save the changes in the heating curve.

#### 4.5.2 Setting the control strategy

The control strategy determines the way in which the thermostat controls the heating of the room or a zone.

1. Enter the main menu.
2. Select **Installer**.
3. Confirm the selection.
4. Select **Yes** to continue.
5. Confirm the selection.

Fig.45

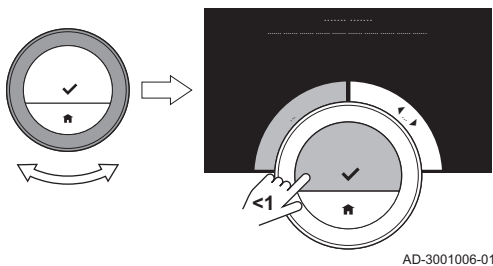
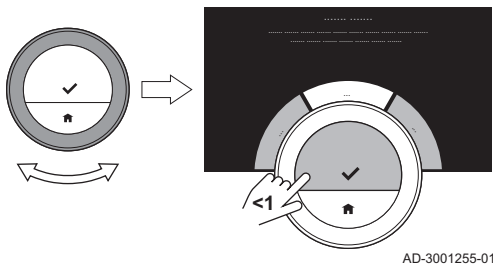

Fig.46



6. Select **Control Strategy**.



**Important**

The display shows **Control Strategy** only if your installation is fit for this option.

7. Confirm the selection.
8. Select the **Control Strategy** that you want:
  - **Room**: the thermostat controls the heating on the basis of the room thermostat.
  - **Outside**: the thermostat controls the heating on the basis of the outside temperature sensor.
  - **Room & Outside**: the thermostat controls the heating on the basis of the outside temperature sensor and the room thermostat.
  - **Automatic**: the thermostat chooses one of the control strategies on the basis of the connected sensors.
9. Confirm the selection.

#### 4.5.3 Setting the heating rate

The heating rate determines how slow or fast the installation will heat up the room or zone at the start time of the scheduled heating period.

1. Enter the main menu.
2. Select **Installer**.
3. Confirm the selection.
4. Select **Yes** to continue.
5. Confirm the selection.

Fig.47

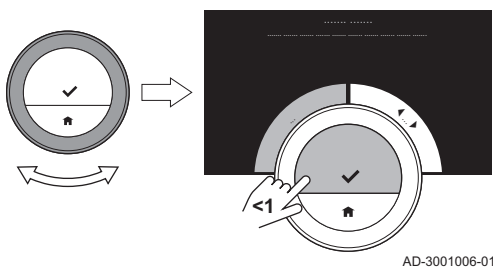
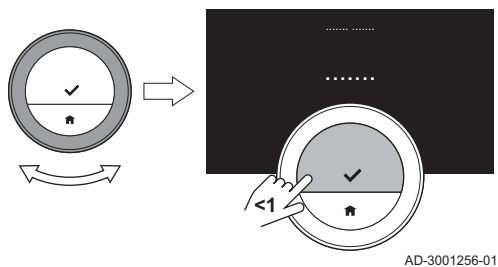

Fig.48



AD-3001256-01

6. Select **Heating rate**.**Important**

The display shows **Heating rate** only if your installation is fit for this option.

7. Confirm the selection.

8. Select the heating rate that you want.

**Important**

The list of available speed indications depends on the appliance in your installation.

9. Confirm the selection.

#### 4.5.4 Setting the minimum central heating power

The minimum central heating power determines what is the lowest heating capacity of your appliance.

1. Enter the main menu.
2. Select **Installer**.
3. Confirm the selection.
4. Select **Yes** to continue.
5. Confirm the selection.
6. Select **Min. power**.

**Important**

The display shows **Min. power** only if your installation is fit for this option.

Fig.49

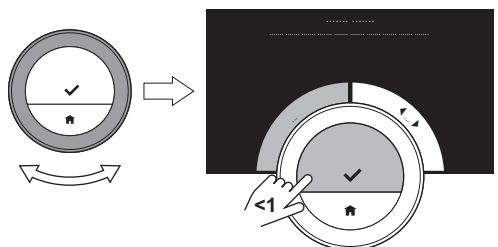

AD-3001006-01

Fig.50

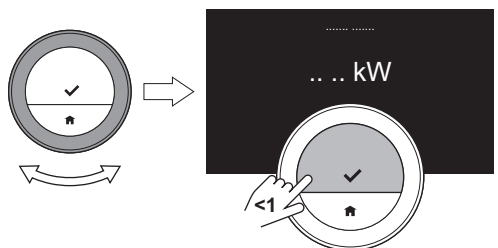

AD-3001257-01

7. Confirm the selection.

8. Turn the rotary dial to select the number of kW.

9. Confirm the selection.

#### 4.5.5 Setting the maximum central heating power

The maximum central heating power determines what is the highest heating capacity of your appliance.

1. Enter the main menu.
2. Select **Installer**.
3. Confirm the selection.
4. Select **Yes** to continue.
5. Confirm the selection.

Fig.51

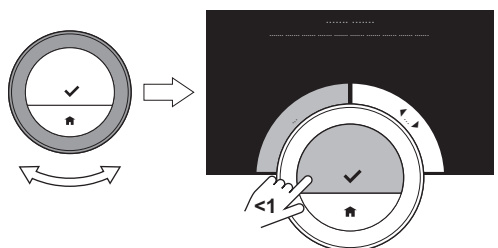

AD-3001006-01

Fig.52

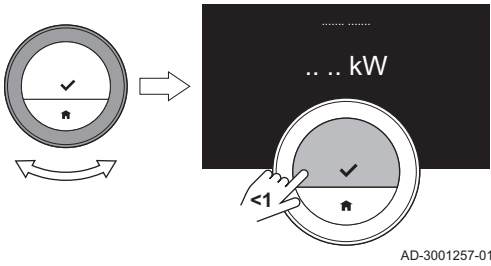

6. Select **CH Max. power**.



**Important**

The display shows **CH Max. power** only if your installation is fit for this option.

7. Confirm the selection.
8. Turn the rotary dial to select the number of kW.
9. Confirm the selection.

#### 4.5.6 Setting maximum domestic hot water power

The maximum domestic hot water power determines what is the highest capacity of your appliance for producing hot tap water.

1. Enter the main menu.
2. Select **Installer**.
3. Confirm the selection.
4. Select **Yes** to continue.
5. Confirm the selection.
6. Select **DHW Max. power**.



**Important**

The display shows **DHW Max. power** only if your installation is fit for this option.

7. Confirm the selection.
8. Turn the rotary dial to select the number of kW.
9. Confirm the selection.

Fig.53

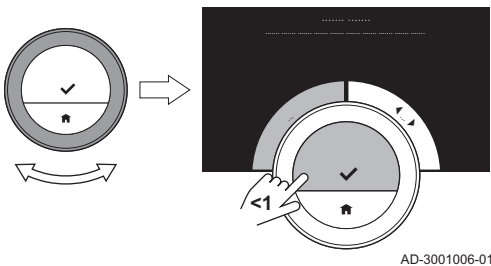
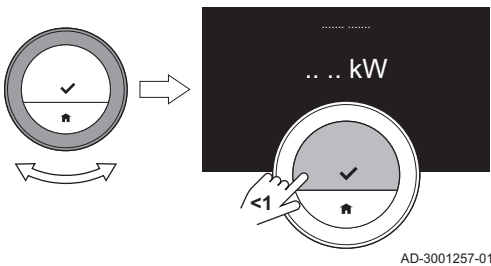

Fig.54



#### 4.5.7 Register predictive maintenance

The installer can register the thermostat to the central server. The server will receive data from the thermostat and the appliance. At some moment the server will give a signal to the installer that he should execute a timely maintenance activity. In this way good functioning of the appliance is ensured and unnecessary costs for the user are prevented.

Instruction for the installer:

1. Enter the main menu.
2. Select **Settings**.
3. Confirm the selection.
4. Select **Register predictive maintenance**.
5. Read the registration code or scan the QR code.
6. Register the code in the app connected to the central server.

Once a month the thermostat will send data about the functioning of the appliance to the server. For instance the number of operating hours, water pressure, temperature, etc. The thermostat will send instantly a message to the server when the appliance has an error. The server will send a signal to the installer when maintenance is necessary.

The data and messages are only sent to the server if:

- The appliance is fit for this option.
- The user has agreed on the data exchange after reading the Privacy Policy.
- The user has connected the thermostat to the app.



## 5 Messages and data

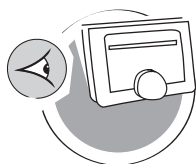

AD-3001026-01

This chapter helps you with navigating to information and data of the thermostat and system.

- Next chapter: Installation, page 37
- ← Previous chapter: Customisation, page 20
- 🏠 First chapter: Manual menu, page 4

### 5.1 Outside temperature

You can read the outside temperature if an external temperature sensor is connected to your installation.

1. Enter the main menu.
2. Select **Outside Temperature**.
3. Confirm the selection.
  - ⇒ The display shows the current outside temperature.

### 5.2 Energy consumption

The thermostat can display the energy that was used for heating and hot tap water supply from the moment of first use of the appliance.



#### Important

- This menu item is only available for combi appliances. An appliance that can produce both central heating water and hot tap water.
- This menu item is not available for appliances with an on/off communication protocol.

1. Enter the main menu.
2. Select **Energy Consumption**.
3. Confirm the selection.
  - ⇒ The thermostat displays the current energy consumption.

### 5.3 Installer details

The thermostat can display the name and telephone number of the installer for ease of contact.

1. Enter the main menu.
2. Select **Installer Contact Details**.
  - ⇒ The thermostat displays the contact details of your installer.



#### Important

The installer contact details can be edited in the app on your mobile device.

### 5.4 Appliance data

The thermostat can display some appliance data from your heating installation. If your appliance supports this function, you can read the water pressure and water temperature.



#### Important

This menu item is not available for appliances with an on/off communication protocol.

1. Enter the main menu.
2. Select **Heater**.
3. Select **Water pressure** or **Current Boiler Temperature**.
  - ⇒ The thermostat will now display the appliance data.

## 5.5 Technical information

The thermostat can display various built-in properties and parameters.

1. Enter the main menu.
2. Select **Technical Information**.
3. Confirm the selection.
  - ⇒ The display shows:

Tab.7 Device Information

Serial Number:
Software Version:
Wi-fi SSID:
Wi-fi Connection:
Internet Connection:
Server Connection:
Register Status:
IP Address:
MAC Address:
Server up time:
Wi-fi up time:
date:
time:
Time server:

Tab.8 Appliance Information

Name:
Software Version:
Connection:
date:
time:

Tab.9 Miscellaneous

License Information Open
Logging Send to Server

## 5.6 Error messages overview

You can open the error messages list from the main menu to get an overview of all error messages.

1. Enter the main menu.
2. Select **Error History**.
3. Confirm the selection.
  - ⇒ The display shows the list of error messages.



### Important

The list contains the complete history of error messages. Only one error message can be active at a time and it is situated at the top of the list.

Fig.55

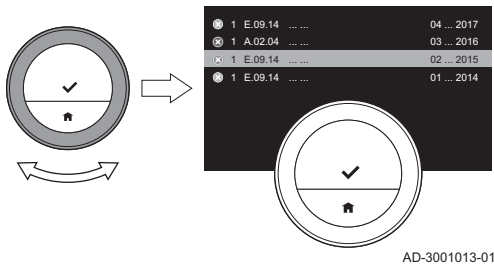

4. Select the active error message.

Fig.56

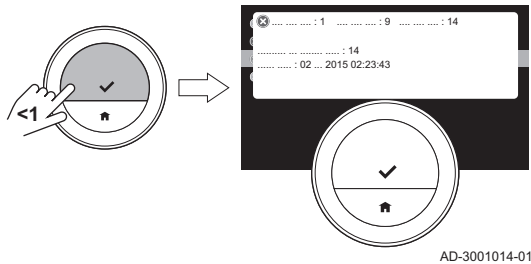

5. Confirm the selection and read the message for more details.
6. If you cannot solve the problem yourself: Note down the error message code and contact your installer.

## 5.7 Service message

The thermostat shows a service message **Please contact maintainer with service code: %1** in the top right hand corner of the display when the appliance needs maintenance.

Fig.57

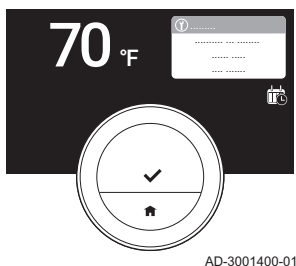

### Important

The service code is:

- **A:** Minor maintenance required.
- **B:** Medium maintenance required.
- **C:** Major maintenance required, including component replacement.
- **Custom:** The appliance is from an unknown brand. The extent of the required maintenance is unknown.

Fig.58

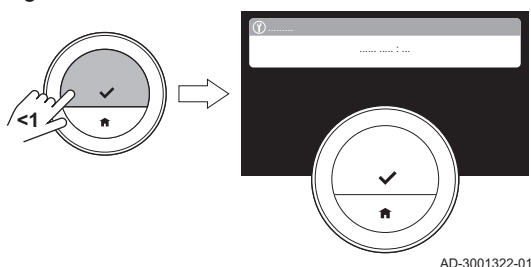

1. Short-press the select button.  
⇒ The Wi-Fi Thermostat shows the message in the top of the display.

Fig.59

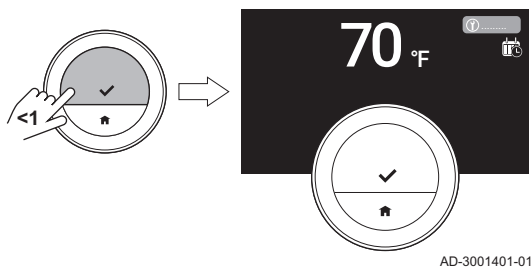

2. Short-press the select button.  
⇒ The thermostat shows a small message in the top right hand corner of the display.



### Important

Every time you start the thermostat, it will show the service message in the top right hand corner of the display again until the maintenance has been executed. Repeat the steps to view the content of the service message.

## 5.8 Sending error information to manufacturer

When the thermostat or the appliance has an error, you can send error information to the manufacturer.



**Important**

If predictive maintenance has been registered, the thermostat will send an automatic message when the appliance has an error.

1. Enter the main menu.
2. Select **Technical Information**.
3. Confirm the selection.
4. Select **Send to Server**.
5. Confirm the selection.
  - ⇒ The thermostat will send information to the manufacturer:
    - The error code.
    - Usage data of the thermostat and the appliance from maximum the last four days.
  - The display will show a message: **The logging will be sent to the server.**
6. Inform the customer service center of your manufacturer about the problem.
  - ⇒ The customer service center can analyse the error code and usage data to assess the problem and advise about the solution.

## 6 Installation

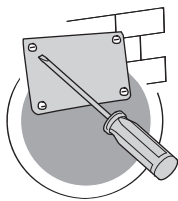

AD-3001027-01

This chapter helps you with the installation and commissioning of the thermostat.

→ Next chapter: Troubleshooting, page 40

← Previous chapter: Messages and data, page 33

🏠 First chapter: Manual menu, page 4

### 6.1 System overview

Fig.60

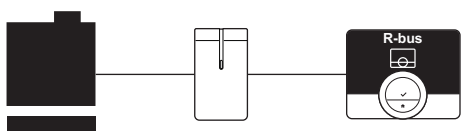

AD-3001019-01

#### 6.1.1 System with gateway

If your heating appliance does not have the R-bus protocol, you need a gateway to connect the thermostat to the appliance. The gateway offers three communication protocols:

- On/off protocol
- OpenTherm protocol
- BSB protocol

The communication protocol depends on the requirements of the appliance. Consult your installer for technical details about your appliance and information how to connect the Wi-Fi Thermostat to the appliance. You can connect the thermostat and the gateway yourself, or ask your installer.



**For more information, see**  
Setup procedure, page 39

### 6.2 Standard delivery

Fig.61

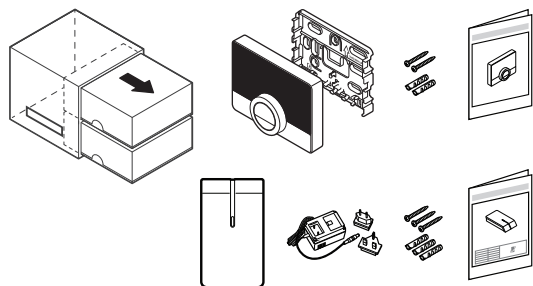

AD-3001022-01

Tab.10 Wi-Fi Thermostat and gateway package

Wi-Fi Thermostat room thermostat
Mounting bracket
Fasteners
Plug fittings
Quick reference guide
Gateway
Power supply
Installation instructions

### 6.3 Preparation

Fig.62

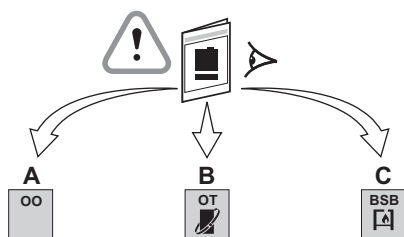

AD-3001015-01

You must check which gateway is needed for the communication between the Wi-Fi Thermostat and your appliance.

1. Check the documentation to know which communication protocol is used for the control of your appliance:

Tab.11 Communication protocol

<b>A</b>	On/off protocol
<b>B</b>	OpenTherm protocol
<b>C</b>	BSB protocol

Fig.63

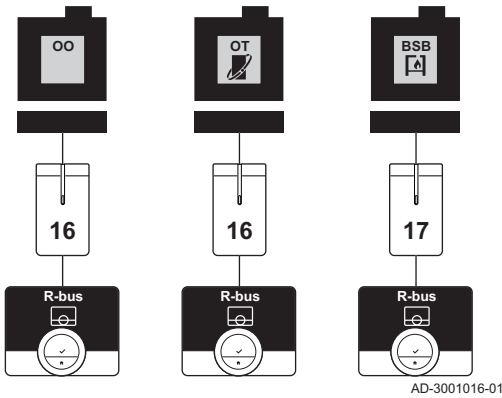

2. Use the diagram to determine which gateway matches the communication protocol of your appliance: Gateway 16 or 17

### 6.4 Installation of the gateway

**Warning**  
 The installation must be performed by a qualified professional.

1. Switch off the appliance.

**Important**  
 Refer to the documentation of the appliance.

2. Install the gateway following the instructions in the gateway documentation.

### 6.5 Location of the Wi-Fi Thermostat

Fig.64

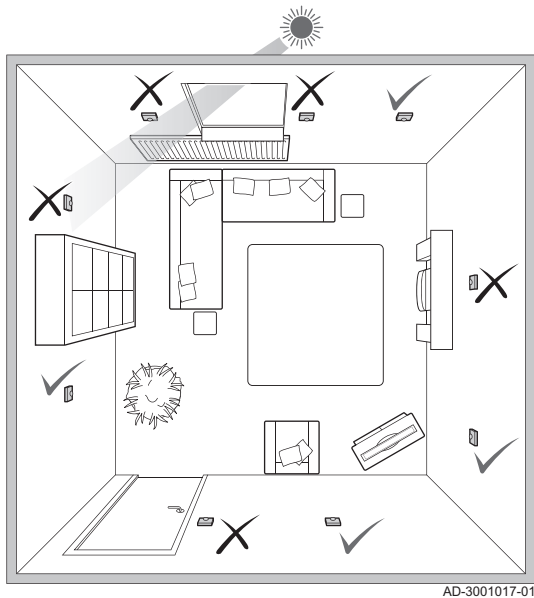

Choose the right location for the Wi-Fi Thermostat.

1. Choose the room where you spend most of your time.
2. Choose a suitable place on the wall:
  - 2.1. Away from heat sources (fire place, radiator, light, candles, direct sunlight, etc.)
  - 2.2. Away from draughts
3. Check that the distance between the Wi-Fi Thermostat and the appliance or gateway does not exceed 50 m (maximum cable length).

### 6.6 Installation of the Wi-Fi Thermostat

The installation of the Wi-Fi Thermostat is described in the Quick Start Guide that is delivered in the thermostat package.

1. Mount the mounting bracket to the wall following the instructions in the Quick Start Guide.
2. Install the thermostat on the mounting bracket following the instructions in the Quick Start Guide.
3. If the thermostat is to control a specific zone, connect the thermostat to the control module.

## 6.7 Setup procedure

---

When the thermostat is connected to the electrical power, the display shows the welcome screen within one minute. The thermostat guides you through the setup procedure.

1. Select the country.
2. Select the language.
3. Select the time zone.
4. Enable daylight saving.
5. Accept the **Terms and Conditions**.



### Important

If you decline the legal **Terms and Conditions** you proceed to the date and time setting and finish the setup procedure. At a later time you can still accept the **Terms and Conditions** and set up your wi-fi connection and app connection.

6. Read the Privacy Policy.
7. Establish a wi-fi connection.
8. Download the app.
9. Connect your mobile device and/or home automation application with the thermostat.



### For more information, see

How to use the Wi-Fi Thermostat, page 6  
 Setting the date and time, page 21  
 Setting country and language, page 21  
 Wi-Fi Thermostat connections, page 25  
 Terms and conditions, page 42

## 6.8 Software update

---

Software updates are available for your thermostat. To update the software the thermostat must be connected to:

- Wi-fi
- The internet
- The server

When all the connections are made the thermostat will automatically update the software.



### Important

The first software update will be available within one day.

It's also possible to manually check the status of the software.



### See

Check for software update, page 28

Each time the software has been successfully updated:

- The thermostat will restart.
- A message will appear on the home screen.

## 7 Troubleshooting



AD-3001028-01

This chapter helps you when there is a problem with the thermostat, an error message will appear on the home screen.

- Next chapter: Appendix, page 42
- ← Previous chapter: Installation, page 37
- 🏠 First chapter: Manual menu, page 4

### 7.1 Error messages

If there is a problem, an error message will appear in the display of the thermostat.

1. Press the select button to see more details about the error.
  - ⇒ The error icon will remain visible in the display until the problem is solved.
2. Open the error messages list to find details on the active error.
3. Solve the problem(s).
4. Reset the error on the appliance. Refer to the manual of the appliance for more information.
  - ⇒ The error icon will disappear from the home screen.



**For more information, see**  
Error messages overview, page 34

### 7.2 Other problems or questions

If you have problems or questions about certain situations, please refer to the table below before you contact your installer for help.

Tab.12 Problems and solutions

Problem	Possible cause	Solution or answer
The display does not show the temperature ring.	The thermostat is in frost protection mode.	In frost protection mode the temperature does not show.
	The current temperature is equal to the target temperature.	The display will show the temperature ring when the temperatures are different.
The thermostat shows a wrong date and time setting.	<ul style="list-style-type: none"> <li>• The power supply of the appliance was interrupted for more than 2 minutes,</li> <li>• or the wi-fi connection does not function,</li> <li>• or the thermostat has no connection to time synchronisation on the internet (NTP).</li> </ul>	<ul style="list-style-type: none"> <li>• Connect the thermostat to the wi-fi network</li> <li>• and to the internet</li> <li>• and to the time synchronization</li> <li>• Or: set the current date and time.</li> </ul>
The display does not go black after 30 seconds.	The presence sensor is set to <b>On</b> and an object is in front of the thermostat.	<ul style="list-style-type: none"> <li>• Put the object at a larger distance.</li> <li>• Set the presence sensor to <b>Off</b>.</li> </ul>
The target temperature cannot be set with the rotary dial.	The thermostat is in frost protection or holiday mode.	Set the thermostat to manual mode or temperature scheduling mode.
The <b>Energy Consumption</b> menu shows no consumption information or a value that seems to be incorrect.	<ul style="list-style-type: none"> <li>• The minimum and maximum power of the appliance is not set correctly in the <b>Installer</b> menu.</li> <li>• Your installation is not fit for this option.</li> </ul>	<ul style="list-style-type: none"> <li>• Ask for the correct power settings of your appliance.</li> <li>• Enter the <b>Installer</b> menu and set:               <ul style="list-style-type: none"> <li>- minimum power for central heating.</li> <li>- maximum power for central heating.</li> <li>- maximum power for domestic hot water.</li> </ul> </li> </ul>



## 8 Maintenance

This chapter helps you with cleaning the thermostat and replacing the batteries.

→ Next chapter: Appendix, page 42

← Previous chapter: Troubleshooting, page 40

### 8.1 Cleaning

---

When the thermostat needs cleaning:

1. Take a soft cloth, preferably micro fiber.
2. Moist it with a mild (non-abrasive, not-alcoholic) detergent.
3. Wipe the surface of the thermostat gently.

## 9 Appendix

This chapter gives you more technical information about the thermostat.

← Previous chapter: Troubleshooting, page 40

### 9.1 Terms and conditions

The legal **Terms and Conditions** are for the wi-fi connection and use of the app. Before you start to setup your wi-fi connection and app connection you have to approve the **Terms and Conditions**.

The **Terms and Conditions** cannot be viewed on the thermostat. You have two options to view them:

- Visit the website of the manufacturer.
- Open the app on your mobile device.

Approve the **Terms and Conditions** after you have read and agreed to them.

If you decide to accept the **Terms and Conditions** you have four extra features with the thermostat:

- You can control your heating system via your mobile device and/or home automation application.
- The thermostat will automatically restore the right date and time after a power outage.
- The thermostat will receive automatic updates with new functions.
- You will be able to report errors of your system to the manufacturer.



**Important**

You have to accept the **Terms and Conditions** only once, unless you reset the default settings of the thermostat.

### 9.2 Disposal

Fig.65

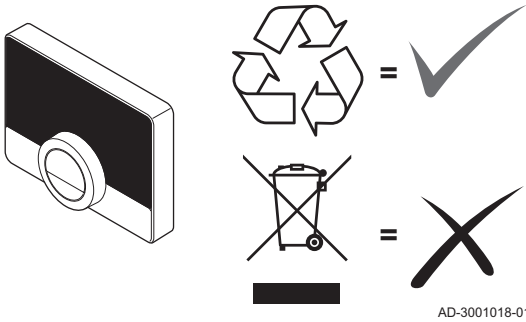

The Wi-Fi Thermostat is a regular electronic device.

Dispose of the Wi-Fi Thermostat in an environmentally friendly way and in accordance with local regulations.

### 9.3 Technical specifications

Tab.13 Dimensions

Width x height x depth (maximum dimensions)	121 x 90 x 29 mm
---	------------------

Tab.14 Power supply

Bus connection voltage	24 V ± 5%
Maximum power consumption	2 W

Tab.15 Electrical connection

Maximum cable length for dedicated Wi-Fi Thermostat bus	50 m
Maximum cable resistance	2 x 5 ohm

Tab.16 Wi-fi connection

Supported frequency band	2.4 Ghz (802.11b/g)
--------------------------	---------------------

Tab.17 Ambient conditions

Storage temperature	from - 13°F to 158 °F
Relative humidity	from 5 % to 95 % Condensation is not allowed
Operating conditions	from 32 °F to 140 °F

Tab.18 Temperature

Room temperature measurement range	from 32 °F to 122 °F <sup>(1)</sup>
Temperature control area	from 50 °F to 86 °F <sup>(1)</sup>
(1) Depends on appliance.	

Tab.19 Compliant with standards

EMC: 2004/108/EC, EN 55022, 55014
Immunity: EN61000-6-2
EN2-6-61000 (EMC part 6.2 Generic Standards)
ETSI-EN 301 489-17 (Electromagnetic compatibility and radio spectrum matters)
R&TTE Directive 1999/5/EC
EN 60950-1 (ITE – Safety – Part 1: General Requirements)
Low voltage directive (2006/96/EC)
WEEE directive (2002/96/EC) (disposal requirements)
Drop test: IEC 60068-2-32
Protection classification: IP21

## 9.4 ErP information

### 9.4.1 Product fiche

Tab.20 Product fiche

Argo - Wi-Fi Thermostat		Wi-Fi Thermostat <sup>(1)</sup>	Wi-Fi Thermostat <sup>(2)</sup>	Wi-Fi Thermostat <sup>(3)</sup>
Class		IV	V	VI
Contribution to space heating energy efficiency	%	2	3	4
(1) Combined with On/Off appliance (2) Combined with modulating appliance (3) Combined with modulating appliance and outdoor sensor				







© Copyright

All technical and technological information contained in these technical instructions, as well as any drawings and technical descriptions supplied, remain our property and shall not be multiplied without our prior consent in writing. Subject to alterations.



2201 Dwyer Avenue, Utica, NY 13501  
Tel. 800 253 7900  
[www.ecrinternational.com](http://www.ecrinternational.com)

All specifications subject to change without notice.  
©2019 ECR International, Inc.

