



User manual
Digital clock thermostat

Wi-Fi Thermostat

Contents

1	Introduction	4
1.1	Symbols used in the manual	4
1.2	Introducing the Wi-Fi Thermostat	4
1.3	The Wi-Fi Thermostat and its app	5
1.4	What's new for the thermostat	5
1.5	How to use the thermostat	5
1.5.1	Using the rotary dial and buttons	5
1.5.2	Activating the thermostat	5
1.5.3	Entering the main menu and menu items	6
1.5.4	Entering the Quick Access menu and menu items	6
1.5.5	Returning to the previous step or home screen	6
1.5.6	Scrolling through menu items and changing settings	7
1.5.7	Display shows no information	7
1.6	Description of the display	7
1.6.1	Description of the icons in the display	8
1.6.2	Customising the home screen display	9
1.7	Messages on the display	10
1.8	Presence detection	10
1.9	Zones control	10
2	General use	11
2.1	Central heating	11
2.1.1	Control heating	11
2.2	Hot tap water	14
2.2.1	Hot water tank	14
2.2.2	Combination boiler	15
3	Customisation	17
3.1	Temperature schedules	17
3.1.1	Change a temperature schedule	17
3.1.2	Multiple schedules	18
3.2	Thermostat settings	19
3.2.1	Setting country and language	19
3.2.2	Date and time settings	19
3.2.3	Changing the name of an activity	20
3.2.4	Changing unit system	20
3.2.5	Presence sensor	21
3.2.6	Child lock	21
3.2.7	Display settings	21
3.2.8	Turning the click sound on/off	23
3.3	Thermostat connections	23
3.3.1	Establishing the wi-fi connection	23
3.3.2	Downloading the app	24
3.3.3	Connecting the app with the thermostat	24
3.3.4	Connecting your home automation application with the thermostat	24
3.3.5	Registering installer access	25
3.4	Advanced settings	25
3.4.1	Resetting to default settings	25
3.4.2	Check for software update	26
3.4.3	Temperature calibration	26
3.4.4	Activating preheating	26
3.5	Installer settings	26
3.5.1	Changing the heating curve	26
3.5.2	Setting the control strategy	27
3.5.3	Setting the heating rate	28
3.5.4	Setting the minimum power	28
3.5.5	Setting the maximum central heating power	29
3.5.6	Setting maximum power for hot tap water	29
4	Messages and data	31
4.1	Outdoor temperature	31
4.2	Energy consumption	31
4.3	Installer details	31
4.4	Appliance data	31

4.5	Technical information	32
4.6	Messages overview	32
4.7	Service message	33
4.8	Sending error information to manufacturer	33
5	Installation	35
5.1	System overview	35
5.1.1	System with gateway	35
5.2	Standard delivery	35
5.3	Preparation	35
5.4	Installation of the gateway	36
5.5	Location of the thermostat	36
5.6	Installation of the thermostat	36
5.7	Setup procedure	37
5.8	Software update	37
6	Troubleshooting	38
6.1	Error messages	38
6.2	Reset after appliance error	38
6.3	Other problems or questions	38
7	Maintenance	40
7.1	Cleaning	40
8	Appendix	41
8.1	Terms and conditions	41
8.2	Disposal	41
8.3	Technical specifications	41
8.4	ErP information	42
8.4.1	Product fiche	42

1 Introduction

This chapter introduces you to the thermostat. You will find basic information, e.g. how to use the rotary dial and buttons plus how to interpret the information on the screen.

➔ Next chapter: General use, page 11

1.1 Symbols used in the manual

This manual contains special instructions, marked with specific symbols. Please pay extra attention when these symbols are used.



Warning

Risk of dangerous situations that may result in minor personal injury.



Caution

Risk of material damage.



Important

Please note: important information.



See

Reference to other manuals or pages in this manual.

1.2 Introducing the Wi-Fi Thermostat

Intended use. It has a cable connection to the appliance. You can connect it to the internet via a wi-fi connection, so you can operate the thermostat with an app on your mobile device.



Warning

Do not use the thermostat for systems that are not in accordance with the intended use.

A simple user interface. You scroll through menus, select and enter options and confirm changes. The thermostat has only two buttons that you can either short-press or long-press. There is one rotary dial to scroll up or down in the menu. It's as easy as that!

Controlling the temperature. Your plans change. No problem, control the temperature as you wish, in manual mode or schedule mode. You can even be flexible by switching between three heating schedules. Do you prefer using your mobile device anywhere in the house or outside? The app is available for iOS and Android.

What do I do when I ...? I want to ...? How do I ...? Are you going away for a holiday? Do you want to make a fire in your fireplace? Do you need hot water? Or do you want a short temperature change? You can find most answers in the "General use" chapter.



For more information, see

General use, page 11

1.3 The Wi-Fi Thermostat and its app

Fig.1

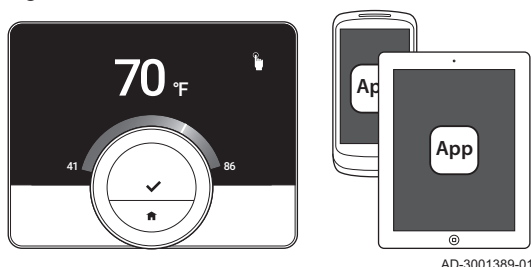

The climate in your home contributes to your comfort; with the Wi-Fi Thermostat thermostat you can control the temperature in your home the way you want it.

If you prefer to control your climate with your mobile device (e.g. smartphone or tablet) you can download the Wi-Fi Thermostat app and connect it with your thermostat. You can also connect your home automation application with the thermostat.



Important

The thermostat needs a reliable connection with other devices (e.g. appliance, wi-fi router) in your home.

1.4 What's new for the thermostat

This document is based on software version 1.70 for the thermostat.

These are the new possibilities of use:

- a new screen to confirm the country that you selected in the setup procedure
- the thermostat can be connected to Rexel.
- you can reset the appliance from the thermostat in a specific situation.

Some texts on the display have changed.

1.5 How to use the thermostat

Before you can use the thermostat, it first needs to be installed.



For more information, see
Installation, page 35

Fig.2

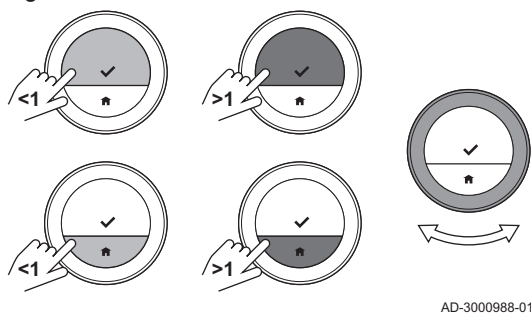

1.5.1 Using the rotary dial and buttons

The rotary dial has two buttons: the top button is the select button, the bottom button is the home button. Pressing a button for a shorter or longer time will start different actions, as shown in this manual.

- **Short button press:** Press less than a second on the button (<1).
- **Long button press:** Press longer than a second on the button (>1).
- **Rotary dial:** Turn the rotary dial to choose and adjust menus, submenus and settings.

1.5.2 Activating the thermostat

The display shows no information (black screen) when for 30 seconds:

- nobody operated the rotary dial
- nobody operated the select button or the home button
- nobody was in front of the thermostat.

If the rotary dial and the buttons were not operated for three minutes in total, the thermostat is in standby mode. It is locked as well, If the child lock is enabled.

To activate the thermostat:

1. Awaken the thermostat (without child lock):
 - 1.1. Go near to the thermostat to activate the presence sensor.
 - 1.2. Press a button.
 - 1.3. Turn the rotary dial.
 - ⇒ The display shows the home screen for 30 seconds if you stay near the thermostat.

2. Unlock the thermostat: when you awaken the thermostat, the display may show **Screen locked**.
 - 2.1. Press the select button for five seconds.
 - ⇒ The display shows **Screen unlocked**.
3. Press the select button to enter the main menu.

i Important
 If you do not enter the main menu while the display shows the home screen, the thermostat will show no information (black screen) again after 30 seconds.

For more information, see
 Child lock, page 21

Fig.3

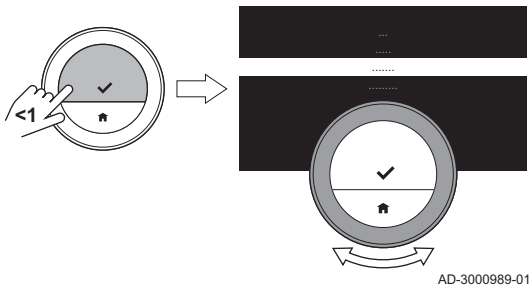

1.5.3 Entering the main menu and menu items

The main menu gives you access to all submenus and settings.

- Short-press the select button to enter the main menu from the home screen.
- Turn the rotary dial forward or backward to select a menu item.
- Short-press the select button to confirm the selection.

Fig.4

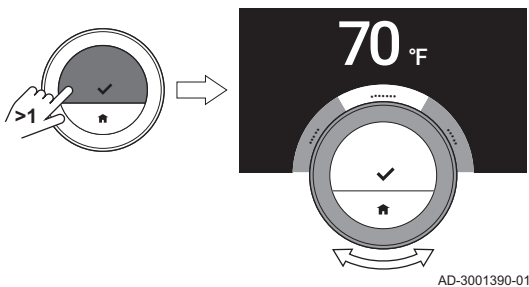

1.5.4 Entering the Quick Access menu and menu items

The Quick Access menu gives you access to a selection of menu items.

- Long-press the select button to enter the Quick Access menu from the home screen.
- Turn the rotary dial forward or backward to select a menu item.
- Short-press the select button to confirm the selection.

Fig.5

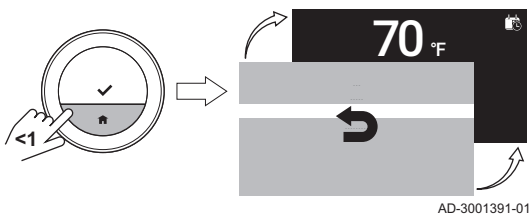

1.5.5 Returning to the previous step or home screen

You can return to the previous step of the menu or return immediately to the home screen.

1. Short-press the home button to return to the previous step.

Fig.6

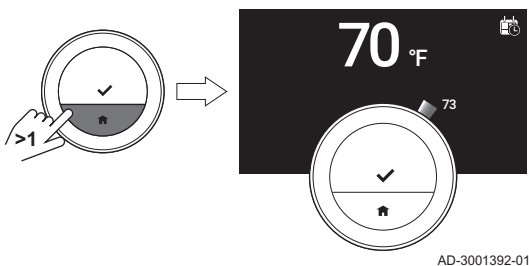

2. Long-press the home button to return to the home screen.

1.5.6 Scrolling through menu items and changing settings

With the rotary dial you can scroll through menu items and change values, temperatures and time settings.

1. Turn the rotary dial to scroll through the menu items.
2. Select the menu item you want to change.
3. Short-press the select button to confirm the selection.
4. Turn the rotary dial to scroll through the submenu items.
5. Select the submenu item you want to change.
6. Short-press the select button to confirm the selection.

Fig.7

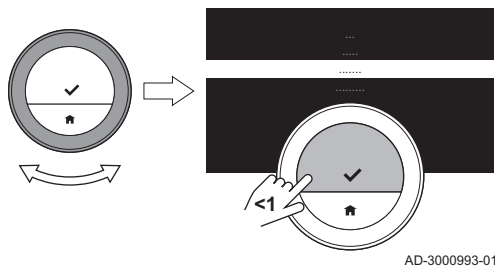
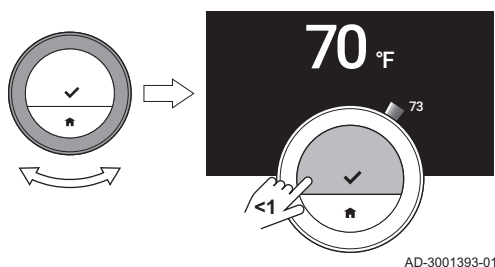

Fig.8



7. Turn the rotary dial to change the setting.
8. Short-press the select button to confirm the selection.

1.5.7 Display shows no information

The display shows no information (black screen) when for 30 seconds:

- nobody operated the rotary dial
- nobody operated the select button or the home button
- nobody was in front of the thermostat.

After these 30 seconds the display is black, but the thermostat is still active and no information is lost.

When the thermostat is not operated for 3 minutes in total, it goes into standby mode. Any unconfirmed setting or selection is lost now. After these 3 minutes the thermostat is locked, if the child lock has been enabled.

Fig.9

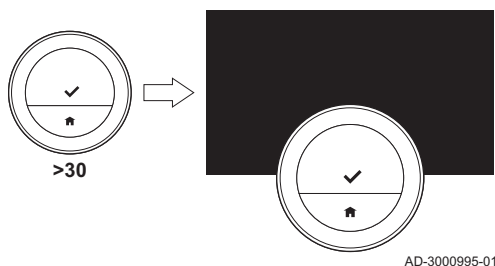

i Important

- Press a button, turn the rotary dial or use the presence sensor to activate the display.
- The thermostat will display the home screen after activation.
- On delivery the presence sensor is active. You can switch off the presence detection.



For more information, see
Presence sensor, page 21

1.6 Description of the display

Fig.10

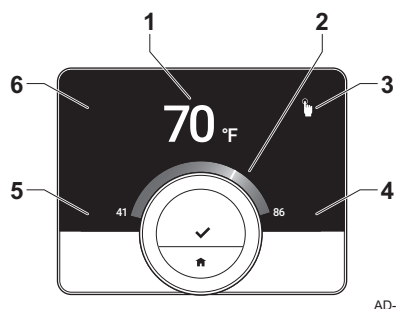

- 1 Current temperature (or target temperature)
- 2 Temperature scale
- 3 Control mode icon
- 4 Home screen information box
- 5 Home screen information box
- 6 Zone icon or Error icon

The temperature scale in the home screen shows the difference between the current and target temperature. The white line represents the current temperature. The target temperature is displayed in small digits next to the scale. The temperature scale is visible when the current temperature differs from the target temperature.



Important

The display shows the current temperature in a large font by default. You can change the display of the temperature to show the target temperature.

1.6.1 Description of the icons in the display







Possible icons in the display (the display shows an icon only if your installation is fit for the related function).

Tab.1 Control mode icons

	Manual mode: Manual mode is active	See Manual mode, page 11 Entering the Quick Access menu and menu items, page 6
	Frost protection mode: frost protection mode is active	See Frost protection, page 13 Entering the Quick Access menu and menu items, page 6
	Holiday period: Holiday period is active	See Holiday mode, page 12 Entering the Quick Access menu and menu items, page 6
	Fireplace mode: Fireplace mode is active	See Fireplace mode, page 13 Entering the Quick Access menu and menu items, page 6
	Temperature scheduling: Temperature scheduling is active	See Scheduling mode, page 11 Entering the Quick Access menu and menu items, page 6
	Short temperature change: Scheduling mode is interrupted for a short temperature change	See Short temperature change, page 11
	Rotary dial: You are turning the rotary dial to set the temperature.	See Manual mode, page 11 Start short temperature change, page 12

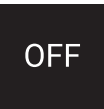
Tab.2 Home screen icons



	Date	See <ul style="list-style-type: none"> Setting the date and time, page 19 Home screen setting, page 22
	Time	See <ul style="list-style-type: none"> Setting the date and time, page 19 Home screen setting, page 22
	Outdoor temperature	See <ul style="list-style-type: none"> Home screen setting, page 22 Outdoor temperature, page 31
	Appliance status: Heating demand	See Home screen setting, page 22
	Appliance status: Heating active	See Home screen setting, page 22

	Appliance mode: On	 See <ul style="list-style-type: none"> • Enable heating, page 0 • Home screen setting, page 22
	Appliance mode: Off	 See <ul style="list-style-type: none"> • Disable heating, page 0 • Home screen setting, page 22
	Appliance mode: Auto	 See <ul style="list-style-type: none"> • Enable heating, page 0 • Home screen setting, page 22

Tab.3 Zone icons

	Basement	
	Bedroom	
	Kitchen	
	Living room	
	Study	
	Swimming pool	
	Generic	

Tab.4 Error icon

	Error display: The appliance reports an active error	 See Messages overview, page 32 Troubleshooting, page 38
	Error display: The thermostat has no internet connection	 See Thermostat connections, page 23

1.6.2 Customising the home screen display

You can configure the home screen of the display by adding two information boxes on the screen, one to the left and one to the right of the rotary dial.

The information boxes can show:

- Time and date
- Detailed information about your system

You can also change the display of the temperature to show the current or target temperature.



For more information, see
 Home screen setting, page 22
 Display current or desired temperature, page 22

1.7 Messages on the display

The display of the thermostat can show several messages:

Tab.5 Messages on the display

Message	Meaning
Help message	The display can show a help message after you change to a different mode. The message informs you about the use of the quick access menu.
Service message	The display shows a service message when the appliance needs maintenance.
Error message	The display shows an error message when the appliance has an error.



Important
 The error code in the error message comes from the appliance.



For more information, see
 Show help messages, page 22
 Service message, page 33
 Messages overview, page 32

1.8 Presence detection

Fig.11

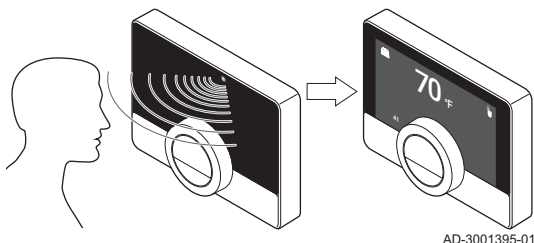

The home screen of the display will light up (for 5 seconds) when the presence sensor detects that a person is in front of the thermostat or passes by. You can disable the presence sensor in the settings menu.



For more information, see
 Presence sensor, page 21

1.9 Zones control

The number of zones depends on the communication protocol of the appliance:

- Rub protocol: you can control an unlimited number of zones. You need one thermostat for every zone. You do not need a gateway.
- BSB protocol: you can control up to three zones. You need one thermostat and one gateway 17 for every zone.
- On/off protocol or OpenTherm protocol: you cannot control multiple zones. You need one thermostat and one gateway 16 for the entire installation.

A zone can be a specific room or, for example a floor.

The zones are named CircA, CircB etc. by default. You can change the names in the app.

2 General use

→ Next chapter: Customisation, page 17

← Previous chapter: Introduction, page 4

2.1 Central heating

You control the heating of the zone with several modes: manual, scheduling, holiday, frost protection and fireplace mode. The display of the thermostat shows the heating icon when heating is active.

2.1.1 Control heating

You can choose from five control modes for heating:

- manual mode
- scheduling mode, which can be interrupted by a short temperature change
- holiday mode
- frost protection mode
- fireplace mode.

■ Manual mode

In manual mode you can change the desired temperature instantly.

1. Check that the thermostat does not operate in manual mode: see the icon in the top-right corner of the home screen.
2. Enter the main menu.
3. Select **Enable Manual Mode**.
4. Confirm the selection.
 - ⇒ The display shows the manual mode icon.
5. Turn the rotary dial to change the desired temperature.

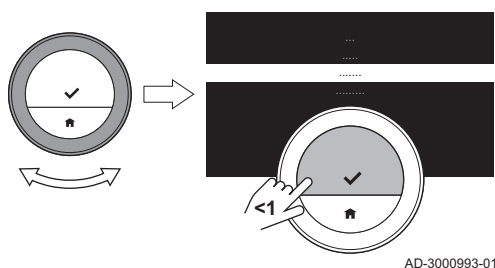

Important

You can also select the manual mode from the Quick Access menu.

■ Scheduling mode

In scheduling mode a week schedule controls the appliance. You can choose from three week schedules, if you selected Enable multiple schedules in the Settings menu. You can interrupt the active schedule for a short period.

1. Check that the thermostat does not operate in scheduling mode: see the icon in the top-right corner of the home screen.
2. Enter the main menu.
3. Select **Enable Temperature Scheduling**.
4. Confirm the selection.
5. Select the desired week schedule.
6. Confirm the selection.
 - ⇒ The display shows the temperature scheduling mode icon and the number of the selected schedule.

You can also select the schedule from the Quick Access menu.

If you want the zone to be heated at the start of the scheduled heating periods, you have to set the preheat period.



For more information, see

Enable multiple schedules, page 18
 Activating preheating, page 26
 Setting the heating rate, page 28
 Change a temperature schedule, page 17

■ Short temperature change

The short temperature change interrupts the scheduling mode for up to 24 hours.

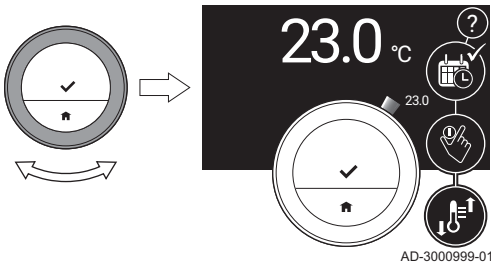

- Start short temperature change

While the thermostat is in scheduling mode, you can select a different target temperature for a short period. At the end of the period the thermostat will return to the scheduled temperature.

1. Check that the thermostat operates in scheduling mode: see the icon in the top-right corner of the home screen.
2. Change the temperature with the rotary dial.
⇒ The display shows the selected temperature and the end time (max 24 hours from now).
3. Long-press the select button if you want to change the end time.
4. Change the period between 0 and 24 hours.



Important

If you change it to 0 hours, the short temperature change is deleted.

- ⇒ The display shows the short temperature change icon and the selected end time.
- 5. Confirm the change.

- Stop short temperature change

The short temperature change will stop at the end of the period. If you want to stop the short temperature change immediately:

1. Check that the thermostat operates in short temperature change mode: see the icon in the top-right corner of the home screen.
2. Enter the main menu.
3. Select **Clear Short Temperature Change**.
4. Confirm the selection.
⇒ The display shows the temperature scheduling mode icon again.

■ Holiday mode

When you will be away for a longer period you can lower the desired temperature to save energy. During the holiday period this desired temperature will overrule the temperature(s) set in scheduling mode or manual mode.

During the holiday period you cannot change the desired temperature. If you try to do so, the display shows a message.

- Create a holiday schedule

1. Enter the main menu.
2. Select **Input Holiday Period**.
3. Confirm the selection.
4. Set the starting date and end date of the holiday period:
 - 4.1. Select an item.
 - 4.2. Confirm the selection.
 - 4.3. Turn the rotary dial to change the item.
 - 4.4. Confirm the change.
5. Set the desired temperature for the holiday period:
 - 5.1. Turn the rotary dial to select **Temperature**.
 - 5.2. Confirm the selection.
 - 5.3. Turn the rotary dial to change the temperature.



Important

The heating appliance in your installation determines what is the minimum temperature for the holiday period.

- 5.4. Confirm the change.
⇒ The display shows: **Holiday period set**.
The display will show the holiday icon in the top right corner of the home screen when the holiday period starts.



Important

The holiday mode can also be set for any other appliance in your installation, such as a hot water generator.

Fig.12

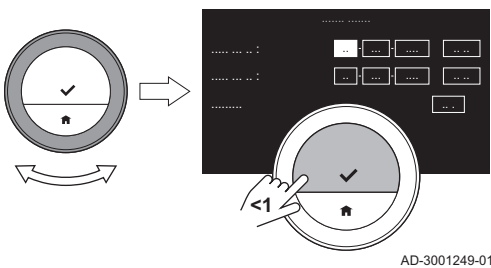

You can create a holiday schedule also from the Quick Access menu.

– Change the holiday schedule

1. Enter the main menu.
2. Select **Input Holiday Period**.
3. Confirm the selection.
4. Select **Edit**.
5. Confirm the selection.
6. Change the period and/or temperature.
7. Select **Save**.
8. Confirm the change.

You can change the holiday schedule also from the Quick Access menu

– Delete the holiday schedule

1. Enter the main menu.
2. Select **Input Holiday Period**.
3. Confirm the selection.
4. Select **Clear**.
5. Confirm the selection.

You can delete the holiday schedule also from the Quick Access menu.

■ Fireplace mode

When for instance a fire is lighted in your fireplace or there is a large number of people in the room, the thermostat in this room will signal to the appliance that it must stop heating. The unwanted effect will be that the other rooms will become cold.

The fireplace mode prevents this effect: the appliance continues to heat on the basis of the heat demand in earlier days.



Important

Activate the Fireplace mode before the other heat source starts heating the room. It may be wise to close the radiators in the warm room during the fireplace mode.

– Activate fireplace mode

1. Enter the main menu.
2. Select **Enable Fireplace**
3. Confirm the selection.
 - ⇒ The display shows the fireplace icon in the top right corner of the home screen.

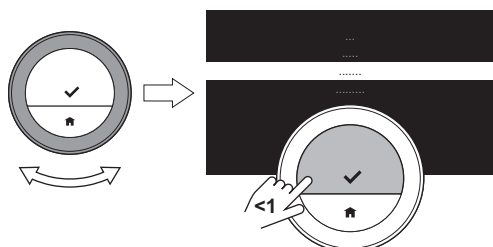

AD-3000993-01

– Deactivate fireplace mode

1. Enter the main menu.
2. Select **Disable Fireplace**.
3. Confirm the selection.
 - ⇒ The display shows the icon of the control mode that was active before the fireplace mode.

You can open the radiators again.

■ Frost protection

You can activate the frost protection mode for central heating and the production of hot tap water, when you will be out of the house in winter for a longer period of time. The heating system will keep the temperature just high enough to avoid frost damage to the house and to the installation. Thus it will save the maximum amount of energy. The heating appliance will heat the installation when the thermostat or a sensor in the appliance measures a temperature below the set frost protection temperature.

Freezing can still occur in rooms that are not heated. Open all radiators and zones of the central heating system to prevent freezing.

Fig.13

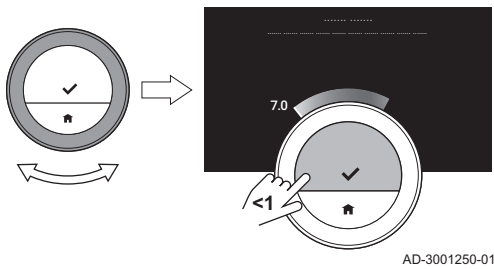

- Activate frost protection mode

1. Enter the main menu.
2. Select **Enable Frost Protection**.
3. Confirm the selection.
 - ⇒ The display shows a message that you can change the frost protection temperature.
4. Long-press the select button while the message is visible.
5. Select the desired frost protection temperature.



Important

The heating appliance determines what is the minimum temperature for the frost protection mode.

6. Confirm the selection.
 - ⇒ The frost protection mode is active and the display shows the frost protection icon in the top right corner of the home screen.



Important

While the thermostat is in frost protection mode you cannot change the target temperature. If you try to do so, the display shows a message.

- Deactivate frost protection mode

1. Enter the main menu.
2. Select **Enable Manual Mode** or **Enable Temperature Scheduling**
 - ⇒ The display shows the icon of the selected mode.

2.2 Hot tap water

If your installation has a combination boiler or a hot water tank, you can control the water temperature in several ways.

You have more options with a hot water tank.

2.2.1 Hot water tank

The hot water tank contains a quantity of hot water at a chosen temperature. When the tank is in comfort mode, this temperature is high and the tap will deliver the hot water fast.

When the tank is in energy saving mode, the water temperature is lower.

■ Select hot water mode

You can choose between a comfort mode and an energy saving mode. The tap will deliver the hot water faster when the appliance is in comfort mode.

1. Enter the main menu.
2. Select **Hot Water**.
3. Confirm the selection.
4. Select **Enable permanent comfort** for setting the appliance to comfort mode.
 - ⇒ In comfort mode the appliance maintains a supply of water at the temperature that you set by the Comfort setpoint.
5. Or select **Enable permanent reduced** for setting the appliance to energy saving mode.
 - ⇒ In energy saving mode the appliance maintains a supply of water at the temperature you set in Reduced setpoint.
6. Confirm the selection.

■ Set the hot water temperature

You can set or change the temperatures of the hot tap water both for the comfort mode and for the energy saving mode.

1. Enter the main menu.
2. Select **Hot Water**.
3. Confirm the selection.
4. Select **Comfort setpoint** or **Reduced setpoint**.

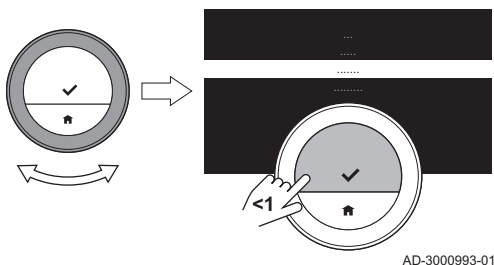

5. Confirm the selection.
6. Select the desired water temperature.
7. Confirm the selection.
 - ⇒ The hot water tank will maintain hot tap water to the set temperature for the active hot water mode.

■ Scheduling mode hot water

In scheduling mode a week schedule controls the periods of comfort mode and energy saving mode for each day.

– Activate the hot water schedule

1. Enter the main menu.
2. Select **Hot Water**
3. Confirm the selection.
4. Select **Enable scheduling**.
5. Confirm the selection.



For more information, see

Change a temperature schedule, page 17

– Short water temperature change

The short water temperature change interrupts the hot water schedule for up to 24 hours. In this period the appliance maintains a supply of water at comfort mode temperature.

1. Enter the main menu.
2. Select **Hot Water**
3. Confirm the selection.
4. Select **Temporary comfort mode** .
 - ⇒ The display shows the duration of the temporary comfort mode: 0 hours and 0 minutes.
5. Select a different duration.
6. Confirm the change.
 - ⇒ At the end of the period, the thermostat will resume the energy saving mode.
7. If you want the thermostat to resume the energy saving mode sooner: select **Re-enable scheduling**.

– Deactivate hot water schedule

1. Enter the main menu.
2. Select **Hot Water**.
3. Confirm the selection.
4. Select **Enable permanent comfort** or **Enable permanent reduced**.
5. Confirm the selection.

2.2.2 Combination boiler

The combination boiler contains a small quantity of hot water at a high temperature when it is in comfort mode. When the tank is in comfort mode, the tap will deliver the hot water fast.

When the tank is in energy saving mode, the combination boiler does not contain any hot water. The tap will take more time to deliver hot water.

■ Select hot water mode

You can choose between a comfort mode and an energy saving mode. The tap will deliver the hot water faster when the appliance is in comfort mode.

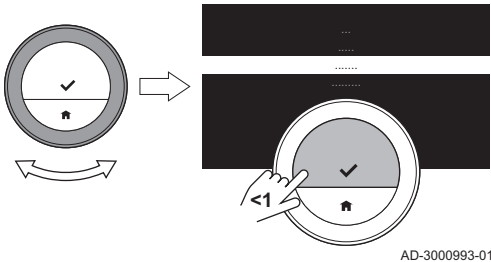

1. Enter the main menu.
2. Select **Hot Water**.
3. Confirm the selection.
4. Select **Enable permanent comfort** for setting the appliance to comfort mode.
 - ⇒ In comfort mode the combination boiler maintains a supply of water at the temperature that you set by the Hot water setpoint.
5. Or select **Enable permanent reduced** for setting the appliance to energy saving mode.
 - ⇒ In energy saving mode the combination boiler does not maintain a supply of hot water.
6. Confirm the selection.

■ Set the hot water temperature

You can set or change the temperature of the hot tap water for the comfort mode.

1. Enter the main menu.
2. Select **Hot Water**.
3. Confirm the selection.
4. Select **Hot water setpoint**.
5. Confirm the selection.
6. Select the desired water temperature.
7. Confirm the selection.
 - ⇒ The combination boiler will maintain a small supply of hot tap water to the set temperature.

■ Scheduling mode hot water

In scheduling mode a week schedule controls the periods of comfort mode and energy saving mode for each day.

- Activate the hot water schedule

1. Enter the main menu.
2. Select **Hot Water**
3. Confirm the selection.
4. Select **Enable scheduling**.
5. Confirm the selection.



For more information, see

Change a temperature schedule, page 17

- Deactivate hot water schedule

1. Enter the main menu.
2. Select **Hot Water**.
3. Confirm the selection.
4. Select **Enable permanent comfort** or **Enable permanent reduced**.
5. Confirm the selection.

3 Customisation

This chapter helps you with customising the thermostat. You will find even more settings on the app.

→ Next chapter: Messages and data, page 31

← Previous chapter: General use, page 11

3.1 Temperature schedules

A temperature schedule enables you to control your heating and hot tap water appliance in a planned way. You can set a week schedule with several periods during each day of the week. For heating you can set three different week schedules.

3.1.1 Change a temperature schedule

When you start the thermostat for the first time, you see one schedule for hot tap water and three schedules for heating. You can change these schedules to your own preferences.

You can customise each day schedule:

- Change the switch time.
- Choose a different activity between two switch times.
- Change the temperature of an activity.
- Add switch times.
- Remove switch times to a minimum of none (resulting in constant temperature all day long based on the last activity from the previous day).

You can change the three week schedules for central heating. For example, you can create time schedules for:

- A week with normal working hours.
- A week with different working hours.
- A week when you are at home most of the time.

■ Copying a weekday of a temperature schedule

You can copy the schedule of one weekday to other weekdays, to speed up the creation of a temperature schedule.

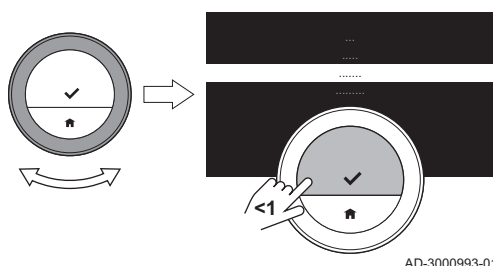

AD-3000993-01

1. Enter the main menu.
2. Select
 - for changing the heating schedule:
 - for changing the hot water schedule:
Hot Water
Change hot water scheduling



Important

The display shows these options only if your installation is fit for them.

3. If multiple schedules is enabled for heating: Select **Schedule 1**, **Schedule 2** or **Schedule 3**.
4. Confirm the selection.
5. Select the weekday you want to copy.
6. Confirm the selected day: rotate the rotary dial to **DONE** and pres the select button.
 - ⇒ The day schedule is opened.
7. Select **Copy** using the rotary dial.
8. Confirm the selection.
 - ⇒ The selected day schedule has been copied.
9. Select and confirm the weekday(s) on which you want to copy the day schedule.
10. Confirm the selected day(s): rotate the rotary dial to **DONE** and press the select button.
 - ⇒ The day schedule has been copied to the selected day(s).

■ **Changing the weekdays of a temperature schedule**

You can change, add or delete temperature intervals in one or more weekdays of a timer program. For example, you can lower the temperature during the night and when you are out of the house. You can set the switch time and the activity (with its temperature) for each interval of the schedule.

1. Enter the main menu.
2. Select
 - for changing the heating schedule:
 - for changing the hot water schedule:
 - Hot Water**
 - Change hot water scheduling**



Important

The display shows these options only if your installation is fit for them.

3. If multiple schedules is enabled: Select **Schedule 1**, **Schedule 2** or **Schedule 3**.
4. Confirm the selection.
5. Select and confirm the day(s) that you want to program.



Important

- When you select more than one day, the days will be assigned the same day schedule.
- Help text on the display above the schedule helps you perform changes.

Fig.14

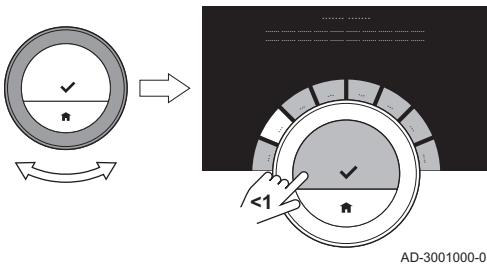

AD-3001000-01

Fig.15

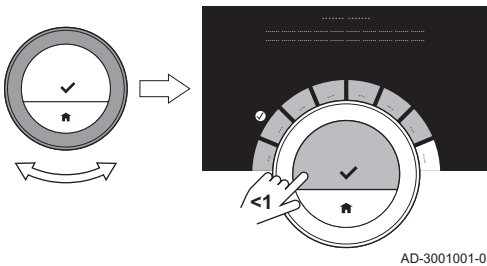

AD-3001001-01

6. Confirm the selected day(s) by rotating the rotary dial to **DONE** and pressing the select button.
7. Change, add or delete activities and switch times.



Important

You can short-press the home button to go back one step.

3.1.2 Multiple schedules

You can control the central heating with three different week schedules if the option for multiple schedules is enabled.

You can enable and disable this option.

■ **Enable multiple schedules**

1. Enter the main menu.
2. Select **Settings**.
3. Confirm the selection.
4. Select **Enable multiple schedules**.
5. Confirm the selection.

■ **Disable multiple schedules**

1. Enter the main menu.
2. Select **Settings**.
3. Confirm the selection.
4. Select **Disable multiple schedules**.
5. Confirm the selection.

3.2 Thermostat settings

3.2.1 Setting country and language

You select the country where you are and the language for the text on your display.

You select your time zone as well.

When you start up the thermostat for the first time, you enter automatically the menu to set the country and language.

During normal operation of the thermostat you can change the country and language settings at a later moment by navigating to the menu.

1. Enter the main menu.
2. Select **Settings**.
3. Confirm the selection.
4. Select **Country and language**.
5. Confirm the selection.
6. Select your country.



Important

You must select the country where you are to ensure that all functions of the thermostat work well.

7. Confirm the selection.
8. Select your language.
9. Confirm the selection.
10. Select your time zone.
11. Confirm your selection.

3.2.2 Date and time settings

You can select several date and time settings for your thermostat:

- set the date and time
- enable or disable time synchronisation by internet
- enable or disable automatic switching to summer time and winter time.

■ Setting the date and time

When you start up the thermostat for the first time, you enter automatically the menu to set the time and date.

You enter this menu also when there has been a power outage and the thermostat has no internet connection.

During normal operation you can change the date and time settings by navigating to the menu.

1. Enter the main menu.
2. Select **Settings**.
3. Confirm the selection.
4. Select **Date time settings**.
5. Confirm the selection.
6. Select **Date time**.
7. Confirm the selection.
8. Change the date and time setting.
9. Confirm the change.

■ Enabling time synchronisation by internet

You can enable or disable the time synchronisation of your thermostat with an NTP server on the internet.

1. Enter the main menu.
2. Select **Settings**.
3. Confirm the selection.
4. Select **Date time settings**.
5. Confirm the selection.
6. Select **Time setting from internet**.

Fig.16

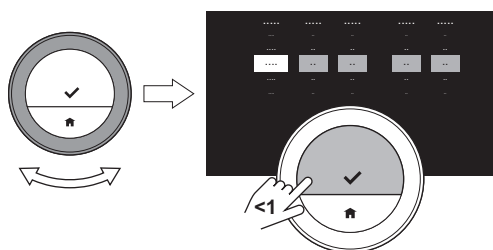

AD-3001251-01

7. Confirm the selection.

3.2.5 Presence sensor

The thermostat has a sensor for presence detection. When you pass by or approach the thermostat, the home screen of the display will light up for 5 seconds. This setting is on by default.

You can switch off the presence detection.

1. Enter the main menu.
2. Select **Settings**.
3. Confirm the selection.
4. Select **Presence sensor detection**.
5. Confirm the selection.
6. Select **Off**.
7. Confirm the selection.



Important

- With the presence sensor switched off, you need to press a button or turn the rotary dial to activate the display. The home screen of the display will light up for 30 seconds.
- Set **Presence sensor detection** to **On** to activate the presence sensor again.

Fig.19

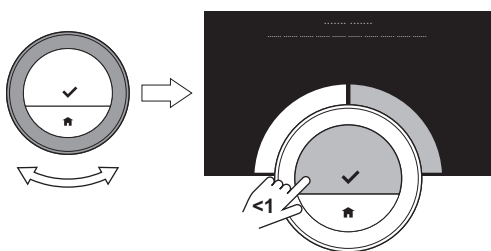

AD-3001007-01

3.2.6 Child lock

The thermostat has a lock function to prevent unwanted access to settings like the desired temperature.

■ Activating the child lock

1. Enter the main menu.
2. Select **Settings**.
3. Confirm the selection.
4. Select **Enable child lock**.
5. Confirm the selection.



Important

It may take some time before the thermostat uses the lock function for the first time.

- ⇒ The display shows **Child lock enabled**. The thermostat will be locked when it goes into standby mode.
If you press a button or turn the rotary dial to reactivate the display, the display shows **Screen locked**.
- 6. Press and hold the select button for more than 5 seconds to unlock the thermostat.
⇒ The display shows **Screen unlocked**.
You can use the thermostat and it will be locked again when it goes into standby mode.

■ Deactivating the child lock

1. Press the select button for more than 5 seconds to unlock the screen.
⇒ The display shows **Screen unlocked**.
2. Enter the main menu.
3. Select **Settings**.
4. Confirm the selection.
5. Select **Disable child lock**.
6. Confirm the selection.
⇒ The display shows **Child lock disabled**. The screen is permanently unlocked.

3.2.7 Display settings

You can change the display settings in several ways.

Fig.20

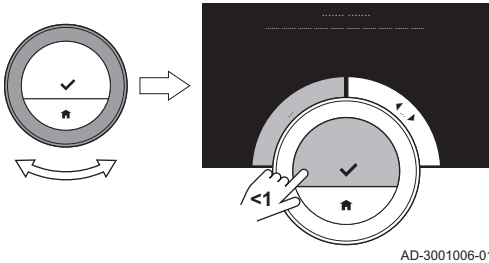

AD-3001006-01

■ **Home screen setting**

You can add two information boxes on the home screen, one to the left and one to the right of the rotary dial.

1. Enter the main menu.
2. Select **Settings**.
3. Confirm the selection.
4. Select **Information boxes**.
5. Confirm the selection.
 - ⇒ The left information box is active.
6. Select one of the options.
7. Confirm the selection.
8. Select the right information box.
9. Confirm the selection.
10. Select one of the options.
11. Confirm the selection.



Important

You can short-press the home button to go back one step.

■ **Display current or desired temperature**

The display shows the current temperature in a large font by default. The desired temperature is in a small font near the temperature scale.

You can change the display of the temperature to show the desired temperature in large font and the current temperature in a small font.

1. Enter the main menu.
2. Select **Settings**.
3. Confirm the selection.
4. Select **Display current or target temperature**.
5. Confirm the selection.
6. Select **Current Temperature** or **Target Temperature**.
7. Confirm the selection.

Fig.21

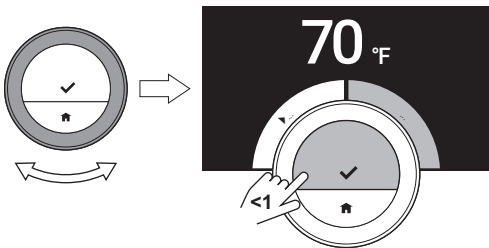

AD-3001399-01

This setting will stay until you change this setting again or reset the thermostat to factory settings.



Important

The instructions in this manual are based on the default setting for current temperature. Changing the display of the temperature influences the instructions given.

■ **Changing the display brightness**

You can change the brightness of the display. The brightness can be set to any value between 10% and 100%.

1. Enter the main menu.
2. Select **Settings**.
3. Confirm the selection.
4. Select **Display brightness**.
5. Choose a brightness level between 10% and 100% using the rotary dial.
6. Confirm the setting.



For more information, see

- Display shows no information, page 7
- Home screen setting, page 22
- Description of the display, page 7

■ **Show help messages**

When you have just started to use the thermostat, the display shows a help message after you change to a different mode. The message informs you about the use of the quick access menu. The display will stop showing these messages after some time.

If you wish to see the messages again:

1. Enter the main menu.
2. Select **Settings**.
3. Confirm the selection.
4. Select **Show help messages**.
5. Confirm the selection.
 - ⇒ The display shows **Show help messages enabled** and the help messages will appear again for some time.

3.2.8 Turning the click sound on/off

When you turn the rotary dial the thermostat makes a click sound at every change. You can choose to turn this click sound off (or on again).

1. Enter the main menu.
2. Select **Settings**.
3. Confirm the selection.
4. Select **Click sound**.
5. Confirm the selection.
6. Select **Off** or **On**.
7. Confirm the setting.

3.3 Thermostat connections

You can operate the thermostat with the Wi-Fi Thermostat app on a mobile device or with a home automation application. This allows you to control the appliance(s) in your installation when you are not near the thermostat. You need a wi-fi network and a mobile device with Apple iOS or Android to make the connection.

3.3.1 Establishing the wi-fi connection

To be able to connect the thermostat to your mobile device, you must first connect the thermostat to your wi-fi network.

When you start up the thermostat for the first time, you enter automatically the menu to connect to your wi-fi network. Before you start to set your wi-fi connection you have to approve the **Terms and Conditions**.



See
Terms and conditions, page 41

During normal operation of the thermostat you can decide to change or reconnect to your wi-fi network at a later moment.

1. Enter the main menu.
2. Select **Settings**.
3. Confirm the selection.
4. Select **Wi-fi**.
5. Confirm the selection.
6. Accept the **Terms and Conditions**.



Important
The display only shows the option to accept the Terms and Conditions when you declined them or when you reset the thermostat to default settings.

7. Select your wi-fi network in the list of available networks.
8. Confirm the selection.
9. Enter the password with the rotary dial and the select button.
10. Select ✓ in the character selection menu to confirm the password.
 - ⇒ The thermostat is now connected to the wi-fi network.

■ Connecting the thermostat to an access point

You can connect the thermostat to an access point in your wi-fi network.

1. Select **WPS Button** in the list of available networks.



Important

If you select **Back**, the display shows the previous screen.

2. Activate the **WPS** on your router (if the router has this option).
 ⇒ The thermostat is now automatically connected to the access point.

■ **Connecting the thermostat to a hidden network**

You can connect to a hidden wi-fi network, if you know the name and password.

1. Select **Other...** in the list in the list of available networks.
2. Enter the network name with the rotary dial and the select button.
3. Select ✓ in the character selection menu.
4. Confirm the selection to save the network name.
5. Select the security mode.
6. Confirm the selection.
7. Enter the password with the rotary dial and the select button.
8. Select ✓ in the character selection menu.
9. Confirm the selection to save the password.
 ⇒ The thermostat is now connected to the hidden wi-fi network.

3.3.2 Downloading the app

You can install the Wi-Fi Thermostat app on your mobile device.

1. Download the free app in the App Store or Google Play. Refer to the information on the box of the thermostat.
2. Start the app and follow the instructions on your mobile device until the app requests a registration code from the thermostat.

3.3.3 Connecting the app with the thermostat

When you start up the thermostat for the first time, you enter automatically the menu to register your app or home automation application. You need an account based on your email address for the connection. During normal operation of the thermostat you can decide to connect or reconnect the app with the thermostat at a later moment.

1. Open the app and create an account in the settings menu.
 ⇒ If you create a new account, you will receive an email message for confirmation.
2. Read the email message.
 ⇒ Check your spam folder if the email does not appear in your inbox.
3. Confirm your account on the website.
4. Enter the main menu of the thermostat.
5. Select **Settings**.
6. Confirm the selection.
7. Select **Register device or service**.
8. Confirm the selection.
 ⇒ The thermostat displays a registration code and QR code.
9. Enter the registration code in the app or scan the QR code with your mobile device.
10. Complete the registration process.

Fig.22

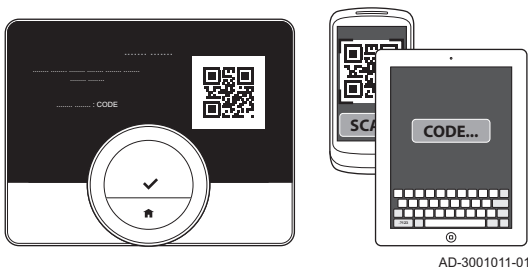

AD-3001011-01

3.3.4 Connecting your home automation application with the thermostat

When you start up the thermostat for the first time, you enter automatically the menu to register your app. You can also connect to Rexel, Alexa, Google Assistant or your home automation application. Your home automation application can be connected if it can communicate with the IFTTT protocol.

You need an account based on your email address for the connection. During normal operation of the thermostat you can decide to connect or reconnect the home automation application with the thermostat at a later moment.

1. Open the home automation application and create an account for the thermostat.
2. Read the email message.
⇒ Check your spam folder if the email does not appear in your inbox.
3. Confirm your account on the website of the manufacturer of the thermostat.
4. Enter the main menu of the thermostat.
5. Select **Settings**.
6. Confirm the selection.
7. Select **Register device or service**.
8. Confirm the selection.
⇒ The display shows a registration code and a QR-code.
9. Enter the registration code in the home automation application or scan the QR-code with your mobile device.
10. Complete the registration process.

3.3.5 Registering installer access

If you want your installer to make any changes or if the service engineer needs information from the installation, you can allow access to your thermostat.

1. Enter the main menu.
2. Select **Settings**.
3. Confirm the selection.
4. Select **Register installer access**.
5. Confirm the selection.
⇒ The display shows the QR code with number and letter code.
6. The installer or service engineer scans the QR code or enters the number and letter code on his app.
⇒ The installer or service engineer now has access to the thermostat for up to 72 hours.

3.4 Advanced settings

3.4.1 Resetting to default settings

You can reset most of the thermostat settings to their default settings at the same time.

Important

- All connection settings for communication will be deleted too!
- The temperature schedules, control mode and holiday period will not be reset.

1. Enter the main menu.
2. Select **Settings**.
3. Confirm the selection.
4. Select **Reset to default settings**.
5. Confirm the selection.
6. Select **Reset**.
7. Confirm the selection.
⇒ The display will show 'welcome' in all languages.
8. Press the select button to continue.
⇒ The setup procedure will start.

 **For more information, see**
Setup procedure, page 37

Fig.23

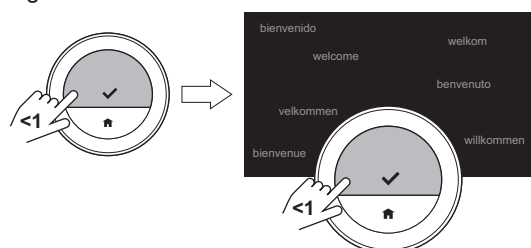

AD-3001012-01

3.4.2 Check for software update

If your thermostat is connected to wi-fi, the internet and the server, software will be updated automatically. You can check the status of the software:

1. Enter the main menu.
2. Select **Settings**.
3. Confirm the selection.
4. Select **Check for software update**.
5. Confirm the selection.
 - ⇒ The display shows the status of the software.

3.4.3 Temperature calibration

You can manually calibrate the temperature if the thermostat displays a temperature that does not correspond with the actual room temperature. This procedure should normally not be necessary.

1. Wait for at least 30 minutes after installation of the thermostat.
2. Measure the actual room temperature.
3. Enter the main menu.
4. Select **Settings**.
5. Confirm the selection.
6. Select **Temperature calibration**.
7. Confirm the selection.
 - ⇒ The display shows the temperature measured by the thermostat as **Temperature detected**.
8. If the detected temperature does not match with the temperature you have measured: turn the rotary dial to change the temperature at **Calibrate this temperature to**.
9. Confirm the change.

i Important

- It may take some time before the thermostat shows the new offset on the **Current Temperature**.
- The new offset will be used over the entire temperature range.

3.4.4 Activating preheating

You can choose to preheat the room or a zone for a set period to give it a set temperature at the start time of the scheduled heating period.

1. Enter the main menu.
2. Select **Settings**.
3. Confirm the selection.
4. Select **Preheat**.
5. Confirm the selection.
6. Turn the rotary dial to change the preheat period.

i Important

If you turn the rotary dial to 0 minutes, the preheat function is deactivated.

7. Confirm the change.

Fig.24

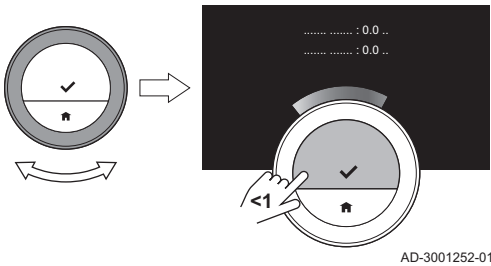

3.5 Installer settings

When you enter the Installer menu, the display shows a warning that the settings in the Installer Menu may affect the performance of your appliance. It may be a better idea that your installer does these settings.

3.5.1 Changing the heating curve

The heating curve relates the water temperature of the heating system to the outside temperature. With a good heating curve the installation can maintain a constant temperature in the room.

Fig.25

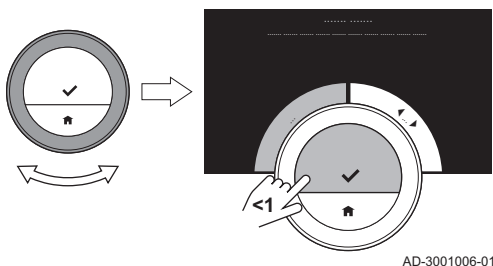

Fig.26

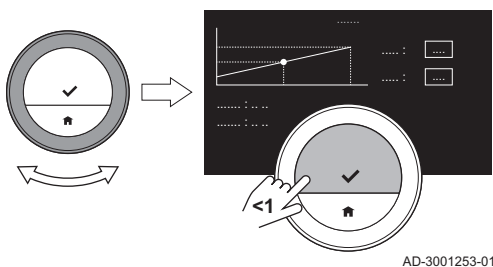

Fig.27

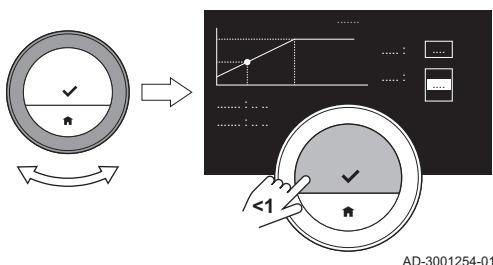
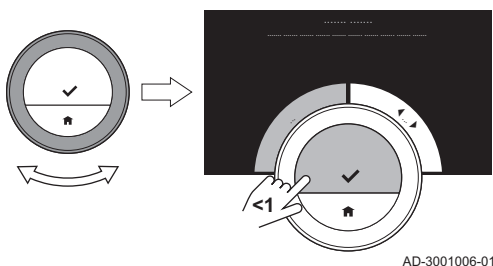

Fig.28



1. Enter the main menu.
2. Select **Installer**.
3. Confirm the selection.
4. Select **Yes** to continue.
5. Confirm the selection.

6. Select **Heating Curve**.

**Important**

The display shows **Heating Curve** only if your installation is fit for this option.

7. Confirm the selection.
⇒ The display shows the heating curve diagram.
8. Short-press the select button to select the central curve point.
9. Use the rotary dial to move the central curve point over the oblique line in order to see the outside temperatures and the related water temperatures in the bottom-left corner.
10. Short-press the select button to deselect the central curve point.
11. Use the rotary dial to select **Min**: (the minimum water temperature of the appliance).
12. Confirm the selection.
13. Use the rotary dial to change the temperature.
14. Confirm the change.
15. Use the rotary dial to select **Slope**: (the steepness of the heating curve).
16. Confirm the selection.
17. Use the rotary dial to change the steepness.
18. Confirm the change.
19. Use the rotary dial to select **Save** at the bottom-right corner of the display.
20. Confirm to save the changes in the heating curve.

3.5.2 Setting the control strategy

The control strategy determines the way in which the heating of the room or a zone is controlled.

1. Enter the main menu.
2. Select **Installer**.
3. Confirm the selection.
4. Select **Yes** to continue.
5. Confirm the selection.

Fig.29

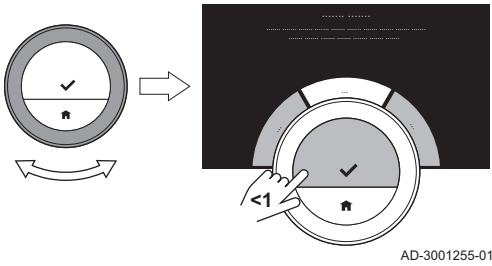

6. Select **Control Strategy**.



Important

The display shows **Control Strategy** only if your installation is fit for this option.

7. Confirm the selection.

8. Select the **Control Strategy** that you want:

- **Room**: the thermostat controls the heating on the basis of the room temperature measured by the thermostat.
- **Outside**: the thermostat controls the heating on the basis of the outdoor temperature sensor or an internet weather service.
- **Room & Outside**: the thermostat controls the heating on the basis of the outdoor temperature and the room temperature.
- **Automatic**: the thermostat chooses one of the control strategies.



Important

If your installation has no outside temperature sensor and no internet weather service has been selected, the display only shows **Room**.

9. Confirm the selection.

3.5.3 Setting the heating rate

The heating rate determines how slow or fast the installation will heat up the room or zone at the start time of the scheduled heating period.

1. Enter the main menu.
2. Select **Installer**.
3. Confirm the selection.
4. Select **Yes** to continue.
5. Confirm the selection.

Fig.30

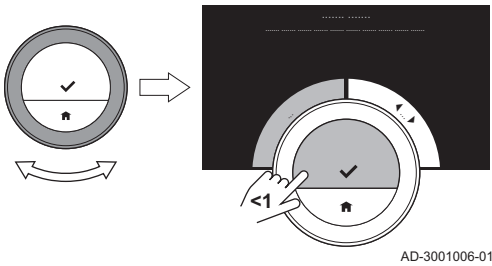
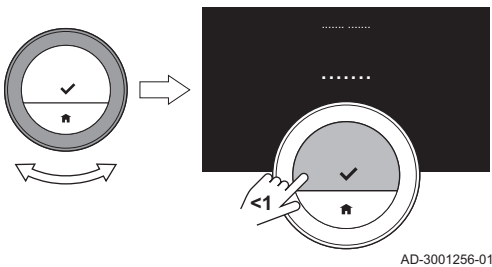

Fig.31



6. Select **Heating rate**.



Important

The display shows **Heating rate** only if your installation is fit for this option.

7. Confirm the selection.

8. Select the heating rate that you want.



Important

The list of available speed indications depends on the appliance in your installation.

9. Confirm the selection.

3.5.4 Setting the minimum power

The minimum central heating power determines what is the lowest heating capacity of your appliance.

You can set the minimum central heating power if your installation has:

- a gateway 16
- the OpenTherm communication protocol.

The thermostat needs the minimum central heating power setting and some other settings to show the total energy consumption.

1. Enter the main menu.
2. Select **Installer**.

Fig.32

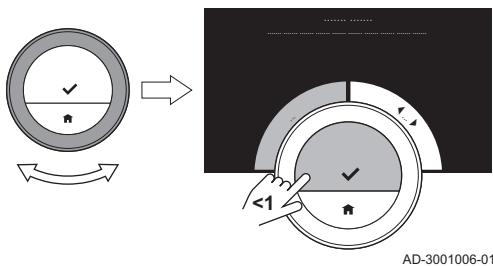

AD-3001006-01

3. Confirm the selection.
4. Select **Yes** to continue.
5. Confirm the selection.
6. Select **Min. power**.

**Important**

The display shows **Min. power** only if your installation is fit for this option.

Fig.33

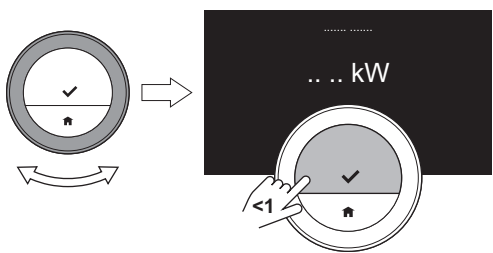

AD-3001257-01

7. Confirm the selection.
8. Turn the rotary dial to select the number of kW.
9. Confirm the selection.

3.5.5 Setting the maximum central heating power

The maximum central heating power determines what is the highest heating capacity of your appliance.

You can set the maximum central heating power if your installation has:

- a gateway 16
- the OpenTherm communication protocol.

The thermostat needs the maximum central heating power setting and some other settings to show the total energy consumption.

1. Enter the main menu.
2. Select **Installer**.
3. Confirm the selection.
4. Select **Yes** to continue.
5. Confirm the selection.

Fig.34

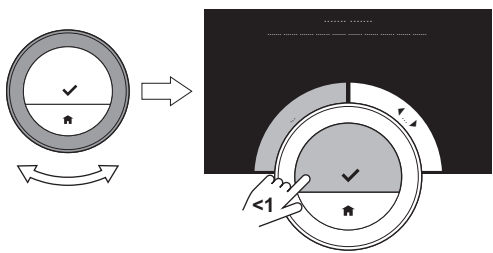

AD-3001006-01

6. Select **CH Max. power**.

**Important**

The display shows **CH Max. power** only if your installation is fit for this option.

7. Confirm the selection.
8. Turn the rotary dial to select the number of kW.
9. Confirm the selection.

Fig.35

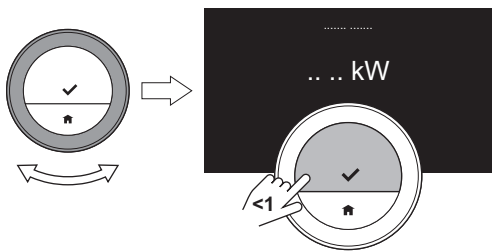

AD-3001257-01

3.5.6 Setting maximum power for hot tap water

The maximum power for hot tap water determines what is the highest heating capacity of your appliance.

You can set the maximum power for hot tap water if your installation has:

- a gateway 16
- the OpenTherm communication protocol.

Fig.36

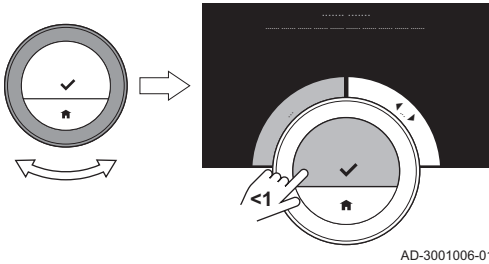
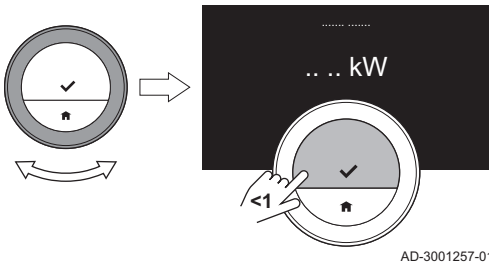

Fig.37



The thermostat needs the maximum power setting for hot tap water and some other settings to show the total energy consumption.

1. Enter the main menu.
2. Select **Installer**.
3. Confirm the selection.
4. Select **Yes** to continue.
5. Confirm the selection.
6. Select **DHW Max. power**.



Important

The display shows **DHW Max. power** only if your installation is fit for this option.

7. Confirm the selection.
8. Turn the rotary dial to select the number of kW.
9. Confirm the selection.

4 Messages and data

This chapter helps you with navigating to information and data of the thermostat and system.

→ Next chapter: Installation, page 35

← Previous chapter: Customisation, page 17

4.1 Outdoor temperature

You can view the outdoor temperature if your installation has an outdoor temperature sensor or if the appliance receives the outdoor temperature from an internet weather service.

You will see the outdoor temperature from a weather service when:

- the heating appliance does not have a connection to an outdoor sensor
- the app has established the location of the thermostat
- the appliance settings state 'Internet' as the type of outdoor sensor.

1. Enter the main menu.
2. Select **Outside Temperature**.
3. Confirm the selection.
 - ⇒ The display shows the current outdoor temperature.

4.2 Energy consumption

The thermostat can display the energy that was used by the appliance for central heating and hot tap water from the moment of first use.

Important

- The display does not show **Energy Consumption** if your appliance has an on/off communication protocol.
- The display only shows the number for **Domestic Hot Water** if you have a combi appliance in your installation. An appliance that can produce both central heating water and hot tap water.

1. Enter the main menu.
2. Select **Energy Consumption**.
3. Confirm the selection.
 - ⇒ The display shows the energy consumption from the moment of first use of the appliance(s).

4.3 Installer details

The thermostat can display the name and telephone number of the installer for ease of contact.

1. Enter the main menu.
2. Select **Installer Contact Details**.
3. Confirm the selection.
 - ⇒ The display shows the contact details of your installer.

Important

The installer contact details can be edited in the app on your mobile device.

4.4 Appliance data

The thermostat can display some appliance data from your heating installation. If your appliance supports this function, you can read the water pressure and water temperature.

Important

This menu item is not available for appliances with an on/off communication protocol.

1. Enter the main menu.

2. Select **Appliance**.
3. Select **Water pressure** or **Current appliance temperature**.
 ⇒ The display shows the selected appliance data.

4.5 Technical information

The thermostat can display various built-in properties and parameters.

1. Enter the main menu.
2. Select **Technical Information**.
3. Confirm the selection.
 ⇒ The display shows:

Tab.6 Device Information

Serial Number:
Software Version:
Wi-fi SSID:
Wi-fi Connection:
Internet Connection:
Server Connection:
Register Status:
IP Address:
MAC Address:
Connection up time:
Wi-fi up time:
date:
time:
Time server:

Tab.7 Appliance Information

Name:
Software Version:
Connection:
date:
time:

Tab.8 Miscellaneous

License Information Open
Logging Send to Server

4.6 Messages overview

You can open a list of service messages, warnings and error messages.

1. Enter the main menu.
2. Select **Error History**.
3. Confirm the selection.
 ⇒ The display shows the list of service messages, warnings and error messages.



Important

The list contains the complete history of the appliance. Only one error message can be active at a time and it is situated at the top of the list.

4. Select the active service message, warnings or error message.

Fig.38

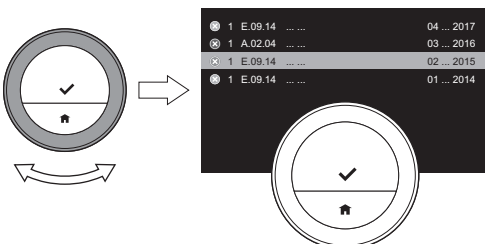

AD-3001013-01

Fig.39

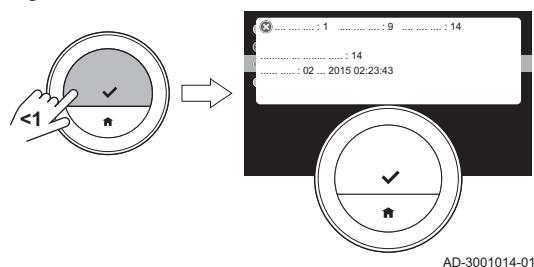

5. Confirm the selection and read the item for more details.
6. If it is an error message and you cannot solve the problem yourself:
Note down the error message code and contact your installer.

4.7 Service message

The thermostat shows a service message **Please contact maintainer with service code: %1** in the top right hand corner of the display when the appliance needs maintenance.

Fig.40

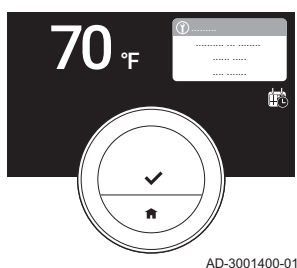

Important

The service code is:

- **A:** Minor maintenance required.
- **B:** Medium maintenance required.
- **C:** Major maintenance required, including component replacement.
- **Custom:** The appliance is from an unknown brand. The extent of the required maintenance is unknown.

Fig.41

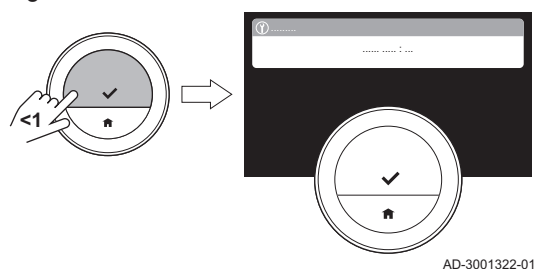

1. Short-press the select button.
⇒ The thermostat shows the message in the top of the display.

Fig.42

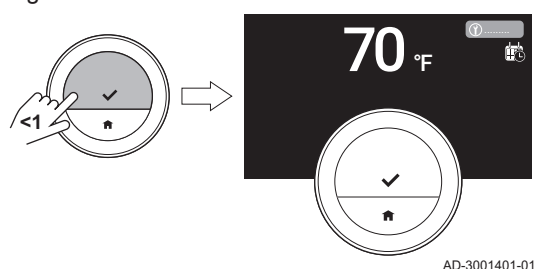

2. Short-press the select button.
⇒ The thermostat shows a small message in the top right hand corner of the display.



Important

Every time you start the thermostat, it will show the service message in the top right hand corner of the display again until the maintenance has been executed. Repeat the steps to view the content of the service message.

4.8 Sending error information to manufacturer

When the thermostat or the appliance has an error, you can send error information to the manufacturer.

1. Enter the main menu.
2. Select **Technical Information**.
3. Confirm the selection.
4. Select **Send to Server**.

5. Confirm the selection.

⇒ The thermostat will send information to the manufacturer:

- The error code.
- Usage data of the thermostat and the appliance from maximum the last four days.

The display will show a message: **The logging will be sent to the server.**

If there is also a problem with the internet connection, the display will show: **No internet connection: the logging will not be sent to the server.**

6. When the information has been sent, inform the customer service center of the manufacturer about the problem.

⇒ The customer service center can analyse the error code and usage data to assess the problem and advise about the solution.

5 Installation

This chapter helps you with the installation and commissioning of the thermostat and its gateway. It also helps you with the connections to the wi-fi network and the app.

➔ Next chapter: Troubleshooting, page 38

➔ Previous chapter: Messages and data, page 31

5.1 System overview

Fig.43

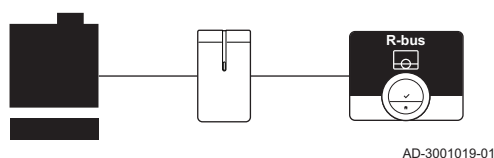

5.1.1 System with gateway

If your heating appliance does not have the R-bus protocol, you need a gateway to connect the thermostat to the appliance. The gateway then offers three communication protocols:

- On/off protocol
- OpenTherm protocol
- BSB protocol

The communication protocol depends on the requirements of the appliance.

Each of the three communication protocols limits the functions of the appliance and the thermostat. The On/off protocol limits the most. Read the manual of the appliance.

Consult your installer for technical details about your appliance and information how to connect the thermostat to the appliance.

You can connect the thermostat and the gateway yourself, or ask your installer.



For more information, see
Setup procedure, page 37

5.2 Standard delivery

Fig.44

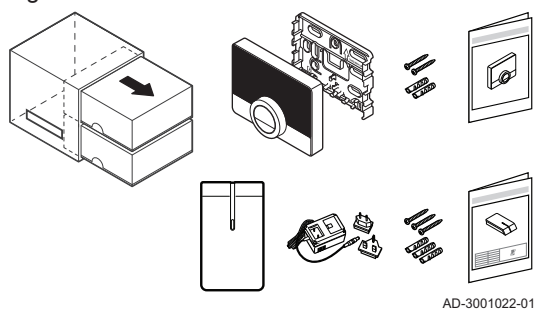

Tab.9 Thermostat and gateway package

Wi-Fi Thermostat room thermostat
Mounting bracket
Fasteners
Plug fittings
Quick reference guide
Gateway
Power supply
Installation instructions

5.3 Preparation

Fig.45

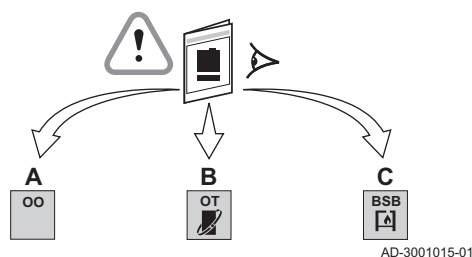

You must check which gateway is needed for the communication between the thermostat and your appliance.

1. Check the documentation to know which communication protocol is used for the control of your appliance:

Tab.10 Communication protocol

A	On/off protocol
B	OpenTherm protocol
C	BSB protocol

Fig.46

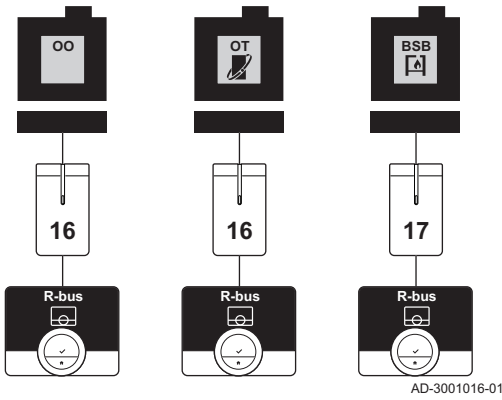

2. Use the diagram to determine which gateway matches the communication protocol of your appliance: Gateway 16 or 17

5.4 Installation of the gateway

Warning
 The installation must be performed by a qualified professional.

1. Switch off the appliance.

Important
 Refer to the documentation of the appliance.

2. Install the gateway following the instructions in the gateway documentation.

5.5 Location of the thermostat

Fig.47

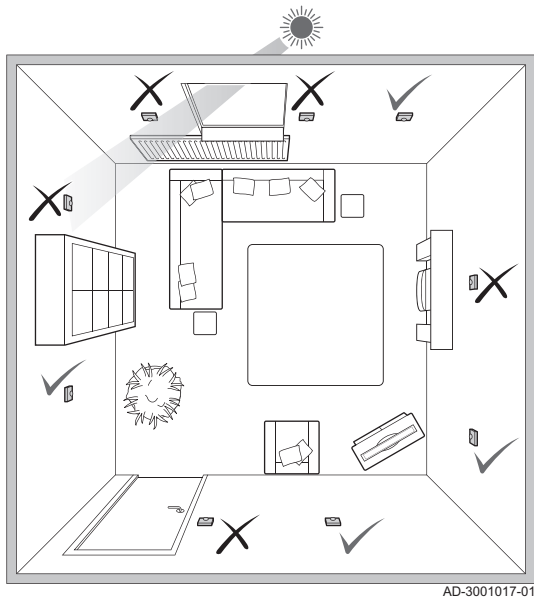

Choose the right location for the thermostat.

1. Choose the room where you spend most of your time.
2. Choose a suitable place on the wall:
 - 2.1. Away from heat sources (fire place, radiator, light, candles, direct sunlight, etc.)
 - 2.2. Away from draughts
3. Check that the distance between the thermostat and the appliance or gateway does not exceed 50 m (maximum cable length).

5.6 Installation of the thermostat

The installation of the thermostat is described in the Quick Start Guide that is delivered in the thermostat package.

1. Mount the mounting bracket to the wall following the instructions in the Quick Start Guide.
2. Install the thermostat on the mounting bracket following the instructions in the Quick Start Guide.
3. If the thermostat is to control a specific zone, connect the thermostat to the control module.

5.7 Setup procedure

When the thermostat is connected to the electrical power, the display shows the welcome screen within one minute. The thermostat guides you through the setup procedure.

1. Select the country.



Important

You must select the country where you are to ensure that all functions of the thermostat work well.

2. Select the language.
3. Confirm the selected country.
4. Select the town that represents your time zone.
5. Enable daylight saving.
6. Accept the **Terms and Conditions**.



Important

If you decline the legal **Terms and Conditions** you proceed to the date and time setting and finish the setup procedure. At a later time you can still accept the **Terms and Conditions** and set up your wi-fi connection and app connection.

7. Establish a wi-fi connection.
8. Download the app.
9. Connect your mobile device and/or home automation application with the thermostat.



Note

After you read the Privacy Policy on your app, the thermostat will be connected to the internet.



For more information, see

How to use the thermostat, page 5
 Setting the date and time, page 19
 Setting country and language, page 23
 Thermostat connections, page 23
 Terms and conditions, page 41

5.8 Software update

Software updates are available for your thermostat. To update the software the thermostat must be connected to:

- Wi-fi
- The internet
- The server

When all the connections are made the thermostat will automatically update the software.



Important

The first software update will be available within one day.

It's also possible to manually check the status of the software.



See

Check for software update, page 26

Each time the software has been successfully updated:

- The thermostat will restart.
- A message will appear on the home screen.

6 Troubleshooting

This chapter helps you when there is a problem with the thermostat, an error message will appear on the home screen.

→ Next chapter: Maintenance, page 40

← Previous chapter: Installation, page 35

6.1 Error messages

If there is a problem, an error message will appear in the display of the thermostat.

1. Press the select button to see more details about the error.
 - ⇒ The error icon will remain visible in the display until the problem is solved.
2. Open the error messages list to find details on the active error.
3. Solve the problem(s).
4. Reset the error on the appliance. Refer to the manual of the appliance for more information.
 - ⇒ The error icon will disappear from the home screen.



For more information, see
Messages overview, page 32

6.2 Reset after appliance error

In a specific situation you may have to reset the heating appliance in your installation:

- your appliance and thermostat are connected by a gateway 17
- and the appliance has an error that may be resolved by a reset from the thermostat.

The display of the thermostat shows the error in the top left corner.

1. Enter the main menu.
2. Select **Installer**
3. Confirm the selection.
4. Select **Yes** to continue.
5. Confirm the selection.
6. Select **Reset the appliance**.
7. Confirm the selection.
8. Select **Yes** to continue.
9. Confirm the selection.
 - ⇒ The display shows a black screen when the reset is in progress.
 - When the reset is not successful, the display shows a message:
Appliance reset failed. Please try again.

Contact your service engineer when you cannot solve the problem.

6.3 Other problems or questions

If you have problems or questions about certain situations, please refer to the table below before you contact your installer for help.

Tab.11 Problems and solutions

Problem	Possible cause	Solution or answer
The display does not show the temperature ring.	The thermostat is in frost protection mode.	In frost protection mode the temperature does not show.
	The current temperature is equal to the desired temperature.	The display will show the temperature ring when the temperatures are different.

Problem	Possible cause	Solution or answer
The thermostat shows a wrong date and time setting.	<ul style="list-style-type: none"> • The power supply of the appliance was interrupted for more than 2 minutes, • or the wi-fi connection does not function, • or the thermostat has no connection to time synchronisation on the internet (NTP). 	<ul style="list-style-type: none"> • Connect the thermostat to the wi-fi network • and to the internet • and to the time synchronisation • Or: set the current date and time.
The display does not go black after 30 seconds.	The presence sensor is set to On and an object is in front of the thermostat.	<ul style="list-style-type: none"> • Put the object at a larger distance. • Set the presence sensor to Off.
The desired temperature cannot be set with the rotary dial.	The thermostat is in frost protection or holiday mode.	Set the thermostat to manual mode or temperature scheduling mode.
The Energy Consumption menu shows no consumption information or a value that seems to be incorrect.	<ul style="list-style-type: none"> • The minimum and maximum power of the appliance is not set correctly in the Installer menu. • Your installation is not fit for this option. 	<ul style="list-style-type: none"> • Ask for the correct power settings of your appliance. • Enter the Installer menu and set: <ul style="list-style-type: none"> - minimum power for central heating. - maximum power for central heating. - maximum power for hot tap water.

7 Maintenance

This chapter helps you with cleaning the thermostat and replacing the batteries.

→ Next chapter: Appendix, page 41

← Previous chapter: Troubleshooting, page 38

7.1 Cleaning

When the thermostat needs cleaning:

1. Take a soft cloth, preferably micro fiber.
2. Moist it with a mild (non-abrasive, not-alcoholic) detergent.
3. Wipe the surface of the thermostat gently.

8 Appendix

This chapter gives you more technical information about the thermostat.

← Previous chapter: Maintenance, page 40

8.1 Terms and conditions

The legal **Terms and Conditions** are for the wi-fi connection and use of the app. Before you start to setup your wi-fi connection and app connection you have to approve the **Terms and Conditions**.

The **Terms and Conditions** cannot be viewed on the thermostat. You have two options to view them:

- Visit the website of the manufacturer.
- Open the app on your mobile device.

Approve the **Terms and Conditions** after you have read and agreed to them.

If you decide to accept the **Terms and Conditions** you have four extra features with the thermostat:

- You can control your heating system via your mobile device and/or home automation application.
- The thermostat will automatically restore the right date and time after a power outage.
- The thermostat will receive automatic updates with new functions.
- You will be able to report errors of your system to the manufacturer.



Important

You have to accept the **Terms and Conditions** only once, unless you reset the default settings of the thermostat.

8.2 Disposal

Fig.48

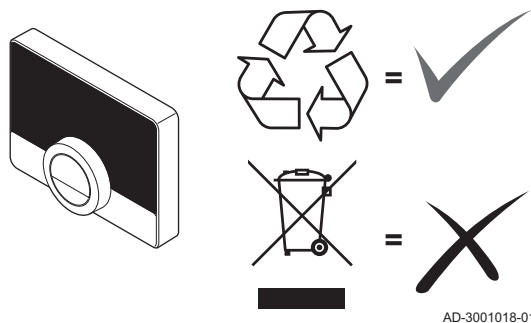

The thermostat is a regular electronic device.

Dispose of the thermostat in an environmentally friendly way and in accordance with local regulations.

8.3 Technical specifications

Tab.12 Dimensions

Width x height x depth (maximum dimensions)	121 x 90 x 29 mm
---	------------------

Tab.13 Power supply

Bus connection voltage	24 V ± 5%
Maximum power consumption	2 W

Tab.14 Electrical connection

Maximum cable length for dedicated Wi-Fi Thermostat bus	50 m
Maximum cable resistance	2 x 5 ohm

Tab.15 Wi-fi connection

Supported frequency band	2.4 Ghz (802.11b/g)
--------------------------	---------------------

Tab.16 Ambient conditions

Storage temperature	from - 13°F to 158 °F
Relative humidity	from 5 % to 95 % Condensation is not allowed
Operating conditions	from 32 °F to 140 °F

Tab.17 Temperature

Room temperature measurement range	from 32 °F to 122 °F ⁽¹⁾
Temperature control area	from 50 °F to 86 °F ⁽¹⁾
(1) Depends on appliance.	

Tab.18 Compliant with standards

Directive	Standard
2014/35/EU Electromagnetic Compatibility Directive (EMC)	EN 55022 Information technology equipment
	EN 55014 Electromagnetic compatibility - Requirements for household appliances, electric tools and similar apparatus
	EN 61000-6-2 Generic standards - Immunity for industrial environments
2014/53/EU Radio Equipment Directive (RED)	ETSI-EN 301 489-17 Electromagnetic compatibility and radio spectrum matters
	EN 60950-1 (ITE – Safety – Part 1: General Requirements)
2014/30/EU Low Voltage Directive (LVD)	
2012/19/EU Waste Electrical & Electronic Equipment (WEEE)	
	IEC 60068-2-32 Drop test
	IP21 Protection classification

8.4 ErP information

8.4.1 Product fiche

Tab.19 Product fiche

Argo - Wi-Fi Thermostat		Wi-Fi Thermostat ⁽¹⁾	Wi-Fi Thermostat ⁽²⁾	Wi-Fi Thermostat ⁽³⁾
Class		IV	V	VI
Contribution to space heating energy efficiency	%	2	3	4
(1) Combined with On/Off appliance				
(2) Combined with modulating appliance				
(3) Combined with modulating appliance and outdoor sensor				

Original instructions - © Copyright

All technical and technological information contained in these technical instructions, as well as any drawings and technical descriptions supplied, remain our property and shall not be multiplied without our prior consent in writing. Subject to alterations.



2201 Dwyer Avenue
Utica, NY 13501
Tel. 800 253 7900
www.ecrinternational.com
www.argocontrols.com

