



Model
VLX - 399
GAS BOILER

**PARTS, KITS &
OPTIONAL ACCESSORIES**

Ordering Instructions

Order Parts through your nearest supplier.

When ordering parts, obtain Model Number and Serial Number from data plate on your boiler.

Include following information when ordering.

Part Number _____

Part Description _____

Boiler Model Number _____

Boiler Serial Number _____



ECR international
EST. 1928
A Family of Heating & Cooling Brands.

Manufactured by:
ECR International, Inc.
2201 Dwyer Avenue, Utica NY 13501
web site: www.ecrinternational.com

TABLE OF CONTENTS

Jacket Kits.....	3
Heat Exchanger Kit.....	4
Burner Replacement Kits.....	5
Igniter Kits.....	6
Flame Sensor Kits.....	6
Gas Valve Kit.....	7
Venturi Kit - 399 MBH.....	8
Blower Kit - 399 MBH.....	9
Condensate Trap Kit.....	10
Control Module Kit.....	11
User Interface kit.....	11
Wire Harness Kit.....	12
Gas Conversion Kit.....	12
High Altitude Kit.....	13
Multi Boiler Sensor Kit.....	13
Misc. Replacement Parts.....	14
Misc. Replacement Parts - Conti.....	15

JACKET KITS

399 Jacket Kit # 550003092			
Item	Description	PART #	QTY
A	Jacket w/Gasket, Logo, Bottom Support, Right and Left Latches, and Handles	-	1

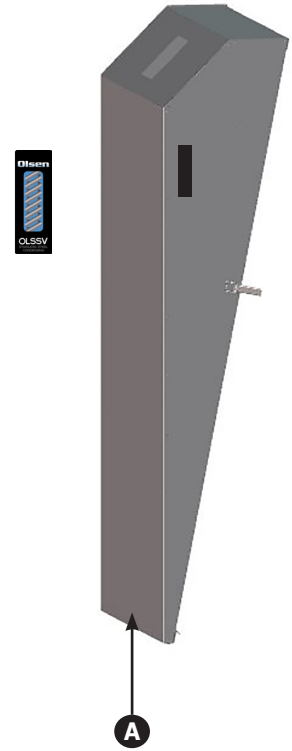

399 BEZEL Kit # 550003094			
<i>KIT INCLUDES ALL ITEMS LISTED</i>			
Item	DESCRIPTION	PART #	QTY
A	Bezel, Window	-	1
B	Bezel Gasket	-	1
C	Display Gasket	-	1
D	Display Panel	109009520	1

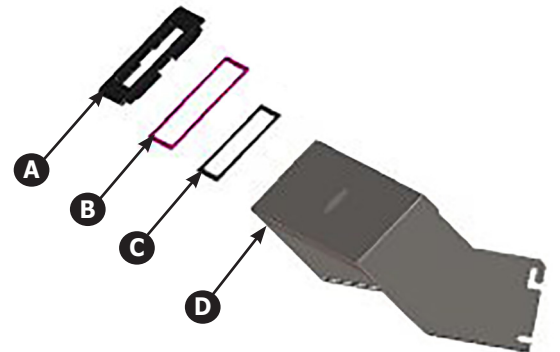

HEAT EXCHANGER KIT

Heat Exchanger with Intergrated Flue Collector- 399 MBH



399 Heat Exchanger Kit # 550003095

KIT INCLUDES ALL ITEMS LISTED BELOW

Item	DESCRIPTION	PART #	QTY
A	Heat Exchanger Module (includes: Heat Exchanger Coil, Top Cap, Igniter, Flame Sensor with Flue Collector Installed)	-	1
B	Fitting, Compression 30mm X 1-1/4 NPT	-	2
*	Instructions	240011189	1

* Not Shown

BURNER KITS

Burner Kits - 399 MBH



399 Burner Inspection Kit # 550003096				
	ITEM	DESCRIPTION	PART #	QTY
Inspection Kit #550003096 includes all items listed	A	Fiber Gasket	-	1
	B	Burner Collar	-	1
	*	Igniter Gasket	-	1
	*	1/4-20 Nut	-	8
	*	8-32 Hex Nut	-	4
	*	Instructions	240010107	1
	* Not Shown			

399 Replacement Burner Kit # 550003097				
	ITEM	DESCRIPTION	PART #	QTY
Replacement Burner Kit #550003097 includes all items listed	A	Fiber Gasket	-	1
	B	Burner Collar	-	1
	C	Burner 399K BTU	-	1
	*	1/4-20 Nut	-	4
	*	Igniter Gasket	-	1
	*	8-32 Hex Nut	-	2
	*	Instructions	240010106	1

IGNITER KITS



399 Igniter Kit # 550002282				
	ITEM	DESCRIPTION	PART #	QTY
Igniter Kit #550002282 includes all items listed	A	Igniter	-	1
	B	Igniter Gasket	-	1
	*	8-32 Hex Nut	-	2
	*	Instructions	240008592	1
* Not Shown				

FLAME SENSOR KITS

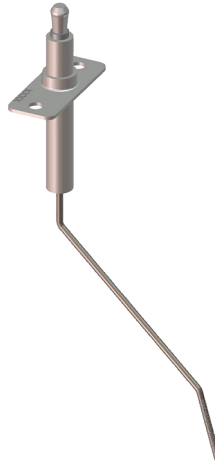

399 Flame Sensor Kit #550002810				
	ITEM	DESCRIPTION	PART #	QTY
Flame Rod Kit #550002810 includes all items listed	A	Sensor Flame 399 MBH	-	1
	*	8-32 Hex Nut	-	2
	*	Instructions	240008593	1
* Not Shown				

GAS VALVE KIT

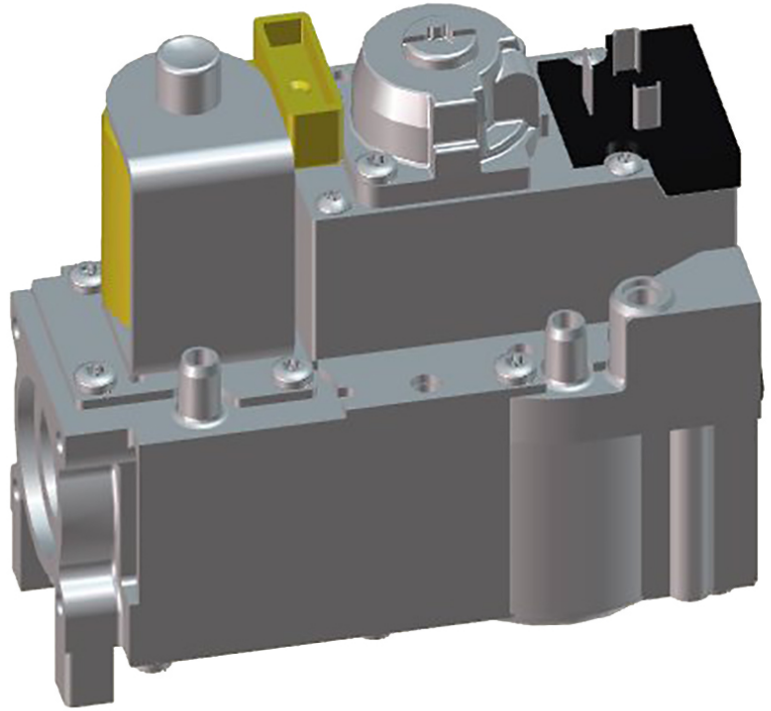
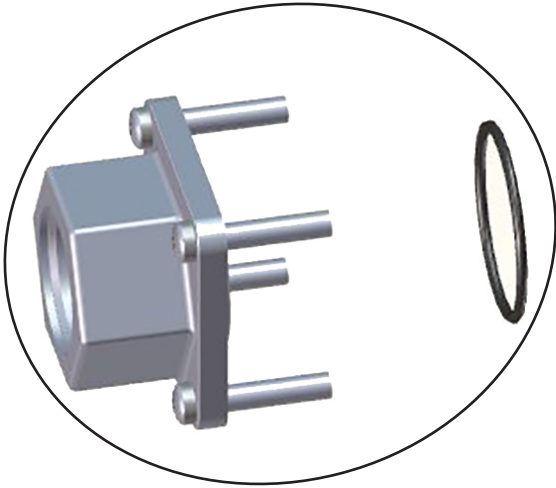

399 Gas Valve Kit # 550002811				
Gas Valve Kit #550002811 includes all items listed	A	Gas Valve, VR4615	-	1
	B	Gas Valve Flange Kit	-	1
	*	Instructions	240011190	1
* Not Shown				

VENTURI KIT - 399 MBH

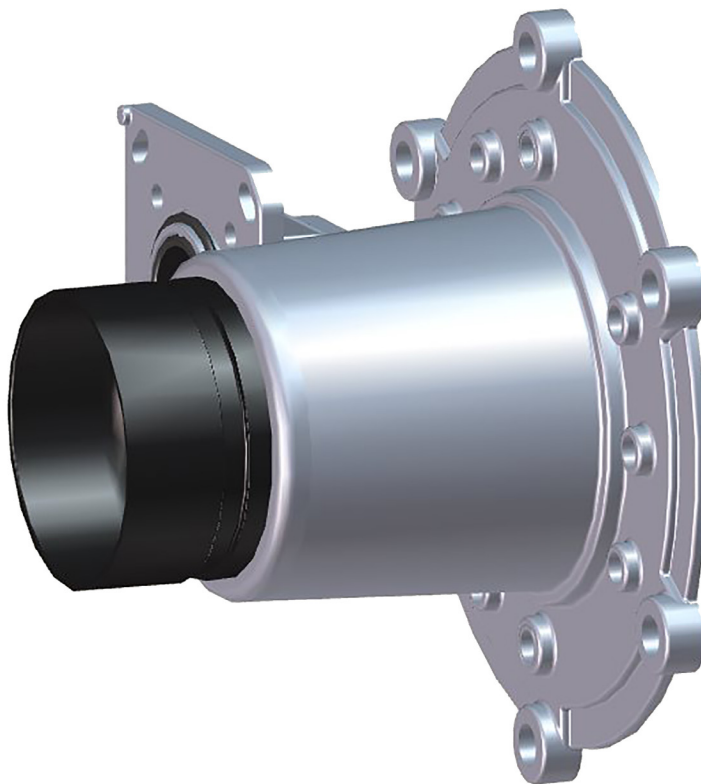

399 Venturi Kit # 550003098				
	ITEM	DESCRIPTION	PART #	QTY
Venturi #550003098 includes all items listed	A	Venturi Integrated	-	1
	*	Instructions	240011190	1

BLOWER KIT - 399 MBH



399 Blower Kit # 550003099				
	ITEM	DESCRIPTION	PART #	QTY
Blower Motor Kit #550003099 includes all items listed	A	Blower, 120 V 50/60 HZ, RG175	-	1
	B	Blower Gasket	-	1
	C	Heat Exchanger Fiber Gasket	-	1
	D	Blower O Ring Gasket	-	1
	*	¼-20 Hex Flange Nut	-	4
	*	Instructions	240011190	1

CONDENSATE TRAP KIT

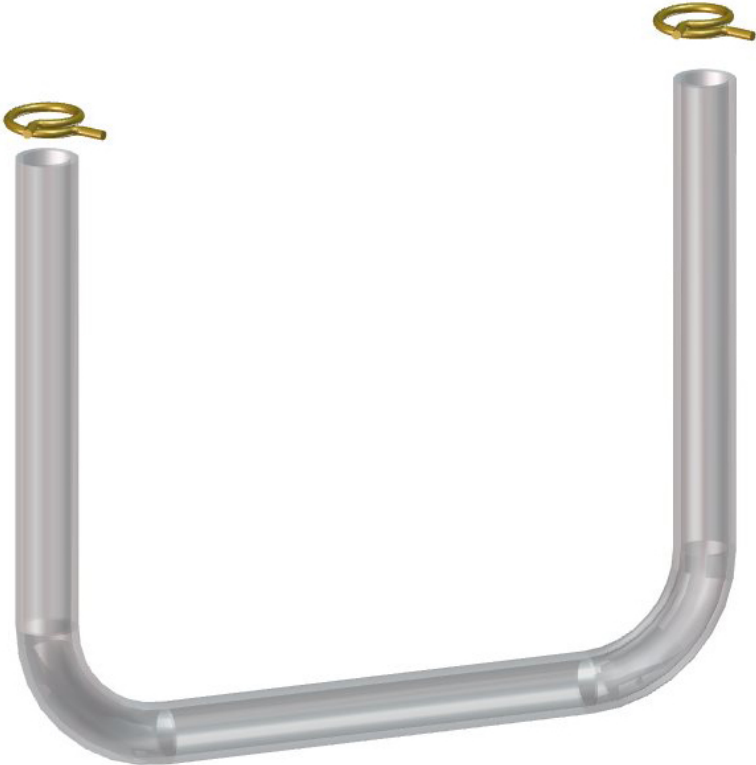

399 Condensate Trap Kit #550003100				
Condensate Trap Kit #550003100 includes all items listed	A	Collet Clip, 1-1/8"	-	2
	B	Condensate Trap	-	1
	*	Instructions	240011191	1
* Not Shown				

CONTROL MODULE KIT

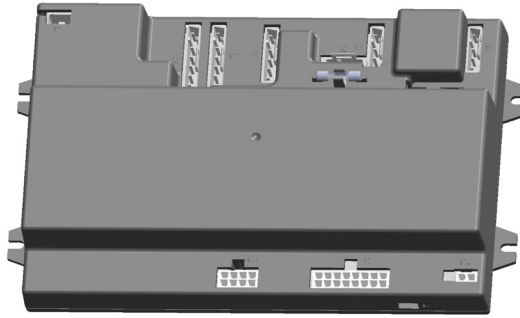

399 Control Module Kit # 550002583				
	ITEM	DESCRIPTION	PART #	QTY
Control Module Kit #550002583 includes all items listed	A	Control Module	-	1
	B	Screw, 8-32x3/8, HWH, Slot Self Tapping	-	4
	C	Spare Fuse, 3.15A ac, 250V, Slo-Blo Glass 5x20mm (Additional fuse included with control module on Boiler)	240008665	1
	*	Instructions	240009314	1
* Not Shown				

NOTE: IF BOILER HAS BEEN CONVERTED TO HIGH ALTITUDE - REPLACE EXISTING CONTROL WITH HIGH ALTITUDE KIT ONLY. SEE PAGE 13.

USER INTERFACE KIT

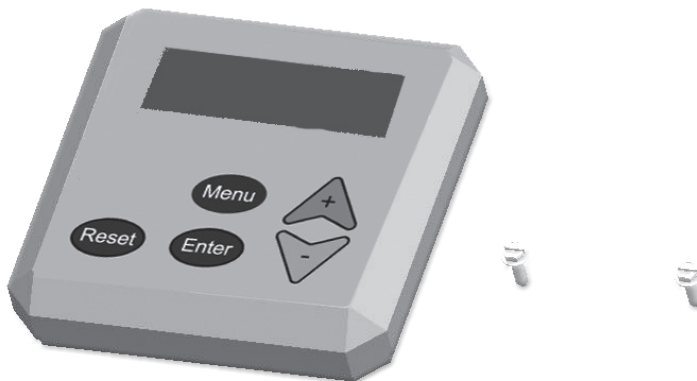

399 User Interface Kit # 550002299				
	ITEM	DESCRIPTION	PART #	QTY
User Interface Kit #550002299 includes all items listed	A	User Interface Control	-	1
	B	Screw, 8-32 x 1/2" Type B	-	2
	*	Instructions	240008930	1
* Not Shown				

WIRE HARNESS KIT

399 Wire Harness Kit # 550003101

Wire Harness Kit #55003101 includes all items listed	Main Boiler Wiring Assembly Harness	-	1
	User Interface Wiring Harness	-	1
	External Limit Harness	-	1
	Screw, 6x3/8, Type B HPH, SZN	-	2
	Screw, 8-32x5/16, Self Tapping, Ground, Green	-	2
	Instructions	240011192	1

GAS CONVERSION KIT

399 Gas Conversion Kit # 550003082

	DESCRIPTION	PART #	QTY
Conversion Kit #550003082 includes all items listed	Orifice, LP,9.6mm	-	1
	Label, "Converted By"	-	2
	Label, "Nat to LP" conversion plate	-	1
	Label, "LP to Nat" conversion plate	-	1
	Instructions	240011155	1

OPTIONAL ACCESSORIES

High Altitude Kit

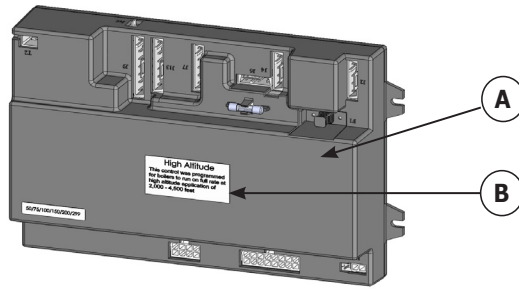







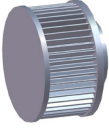
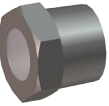

050/075/100/150/299/399 High Altitude Kit # 550002819				
	ITEM	DESCRIPTION	PART #	QTY
High Altitude Kit #550002819 includes all items listed	A	Control Module - High Altitude 2000 - 4500 ft.	-	1
	B	High Altitude label	-	1
	NOT SHOWN	Instructions, High Altitude	240010113	1

Multi Boiler Sensor Kit # 550002186			
	DESCRIPTION	PART #	QTY
Multi Boiler Sensor Kit #550002186 includes all items listed	Sensor, 12K, NTC, 6x45MM	240008465	1
	Well, 1/2 NPT Copper/Brass	240008466	1
	Sensor Well Lock Clip	240008467	1
	Instructions, Multi Boiler Sensor	240008959	1

200/299/399 Condensate Neutralizer Kit # 550003005		
DESCRIPTION	PART #	QTY
Condensate Neutralizer 240010863 includes:		
Double Neutralizer Tube	-	2
3/4" Barbed Y	-	1
3/4" Union	-	2
10Ft 3/4" Hose	-	1
3/4" Hose Clamp	-	6
3/4" NPT to 3/4" Barb	-	3
Neutralizing Material	240010871	2.5 lbs
Base/Wall Mounting Clamp	-	2
Instructions	240010861	1

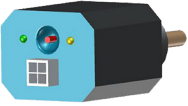
Concentric Vent Kit	
DESCRIPTION	PART #
4" Concentric Vent Kit	240011223

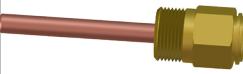
MISC. REPLACEMENT PARTS

Replacement Parts		
	DESCRIPTION	PART #
	Ignitor Cable	240009888
	Intake Air Filter	240011219
	OB PORT, W/ GLASS, 3/4", S305-75	14619002
	Cross, 1 1/4 NPT, Female	240010254
	*Safety Relief Valve (30 PSI) Conbraco 10-407-05	VR-001.01
	*Safety Relief Valve (50 PSI)	VR00102
	LWCO, Hydrolevel Safeguard 1100 MINI, CSD1	240011037
	Honeywell, Aquastat L4006E1109	1010003
	WELL-123870A-3/4 X 1-1/2 HW	1635001
	** Gauge, Temperature Pressure, 2" shank (0 ~ 75 psi)	1260006
	** Gauge, Temperature Pressure, 2" shank (0 ~ 200 psi)	GA00501

Replacement Parts		
	DESCRIPTION	PART #
	High Temperature Supply Switch	240008290
	Sensor, Return Water	240008703
	Sensor, Flue	240008227
	Clamp, 1-1/8" Spring Tension for Condensate Trap	240008406
	Ball Valve 3/4" Female (Gas Shutoff valve) (299)	14657001
	TFMR, 120V PRI, 24V SEC, 15VA	240008279
	Relay, 30A, N/O	240011008
	Relay, 120VAC	240008410
	Heat Exchanger High Temperature Switch L300-40F	240009508
	Boiler Drain Valve	240009323
	Leg, Adj, Glide(4)	240010635

MISC. REPLACEMENT PARTS - CONTI.

Replacement Parts		
	DESCRIPTION	PART #
	Breaker, 10AMP	240011031
	Sensor, Outdoor	240008225
	Fuse, 3.15A AC, 250V, Slo-Blo Glass 5x20mm	240008665
	Draw Latch, Wire Bale, 1-3/8" GAP	240008540
	Hook, Draw Latch, TL-17-202-07	240008541
	Door Handle (2)	28673

* Heating system with system pressure higher than 25 psi, field source proper Safety relief valve.

**Heating systems with low pressure, use 0~75 psi factory supplied pressure temperature gauge. System pressures higher than 60 psi, use optional or field sourced 0~200 psi pressure temperature gauge.



DUNKIRK BOILERS

2201 Dwyer Avenue, Utica NY 13501
web site: www.ecrinternational.com